

 Mensch und Maschine at a glance

All amounts in million EUR (unless stated otherwise)	2014	2015	2016	2017	2018	2019	2020	2021	2022	2023	2024
<b>Revenue</b>	<b>140.0</b>	<b>160.4</b> +15%	<b>167.1</b> +4.2%	<b>160.9</b> -3.7%	<b>185.4</b> +15%	<b>245.9</b> +33%	<b>244.0</b> -0.8%	<b>266.2</b> +9.1%	<b>320.5</b> +20%	<b>322.31</b> +0.6%	<b>325.84</b> +1.1%
Germany	<b>66.9</b> 48%	<b>74.7</b> 46.6%	<b>74.9</b> 44.8%	<b>75.9</b> 47.2%	<b>83.3</b> 44.9%	<b>113.0</b> 45.9%	<b>113.1</b> 46.3%	<b>113.9</b> 42.8%	<b>134.2</b> 41.9%	<b>133.49</b> 41.4%	<b>138.45</b> 42.5%
International	<b>73.1</b> 52%	<b>85.7</b> 53.4%	<b>92.2</b> 55.2%	<b>85.0</b> 52.8%	<b>102.1</b> 55.1%	<b>132.9</b> 54.1%	<b>130.9</b> 53.7%	<b>152.3</b> 57.2%	<b>186.3</b> 58.1%	<b>188.82</b> 58.6%	<b>187.39</b> 57.5%
<b>Gross profit</b>	<b>74.7</b>	<b>84.5</b> +13%	<b>91.4</b> +8.2%	<b>94.8</b> +3.7%	<b>103.9</b> +9.6%	<b>127.9</b> +23%	<b>128.0</b> +0.1%	<b>138.4</b> +8.2%	<b>161.1</b> +16%	<b>168.53</b> +4.6%	<b>174.59</b> +3.6%
M+M Software	<b>36.6</b> 49%	<b>39.6</b> 46.8%	<b>44.7</b> 48.9%	<b>48.9</b> 51.6%	<b>54.3</b> 52.3%	<b>69.7</b> 54.5%	<b>68.9</b> 53.8%	<b>76.1</b> 55.0%	<b>87.5</b> 54.3%	<b>94.95</b> 56.3%	<b>99.03</b> 56.7%
M+M Digitization	<b>38.1</b> 51%	<b>44.9</b> 53.2%	<b>46.7</b> 51.1%	<b>45.9</b> 48.4%	<b>49.6</b> 47.7%	<b>58.2</b> 45.5%	<b>59.1</b> 46.2%	<b>62.3</b> 45.0%	<b>73.6</b> 45.7%	<b>73.59</b> 43.7%	<b>75.56</b> 43.3%
<b>Operating profit EBITDA</b>	<b>10.9</b>	<b>12.8</b> +18%	<b>15.8</b> +23%	<b>18.0</b> +14%	<b>22.7</b> +26%	<b>36.5</b> +61%*	<b>40.3</b> +10%	<b>44.4</b> +10%	<b>52.7</b> +19%	<b>56.64</b> +7.5%	<b>56.74</b> +0.2%
EBITDA return from revenue	7.8%	8.0%	9.4%	11.2%	12.3%	14.9%	16.5%	16.7%	16.4%	17.6%	17.4%
<b>Operating profit EBIT</b>	<b>6.8</b>	<b>8.5</b> +25%	<b>12.5</b> +47%	<b>15.2</b> +22%	<b>19.7</b> +29%	<b>27.2</b> +38%	<b>31.0</b> +14%	<b>34.7</b> +12%	<b>42.6</b> +23%	<b>46.83</b> +10%	<b>46.47</b> -0.8%
EBIT return from revenue	4.9%	5.3%	7.5%	9.5%	10.6%	11.1%	12.7%	13.0%	13.3%	14.5%	14.3%
<b>Net profit after minorities</b>	<b>3.7</b>	<b>3.9</b> +4.0%	<b>6.6</b> +70%	<b>8.5</b> +30%	<b>11.7</b> +37%	<b>16.7</b> +43%	<b>18.7</b> +12%	<b>21.3</b> +14%	<b>26.0</b> +22%	<b>28.87</b> +11%	<b>30.49</b> +5.6%
Net return from revenue	2.7%	2.4%	3.9%	5.3%	6.3%	6.8%	7.7%	8.0%	8.1%	9.0%	9.4%
<b>per share in EUR</b>	<b>0.24</b>	<b>0.24</b>	<b>0.40</b>	<b>0.525</b>	<b>0.715</b>	<b>0.99</b>	<b>1.115</b>	<b>1.26</b>	<b>1.55</b>	<b>1.72</b>	<b>1.80</b>
<b>Operating cash flows</b>	<b>6.3</b>	<b>14.7</b> +134%	<b>14.6</b> -0.1%	<b>15.2</b> +4.0%	<b>15.2</b> +0.2%	<b>26.3</b> +73%*	<b>33.7</b> +28%	<b>36.9</b> +9.4%	<b>39.0</b> +5.8%	<b>50.59</b> +30%	<b>62.32</b> +23%
<b>per share in EUR</b>	<b>0.40</b>	<b>0.91</b>	<b>0.90</b>	<b>0.935</b>	<b>0.93</b>	<b>1.57</b>	<b>2.01</b>	<b>2.18</b>	<b>2.33</b>	<b>3.02</b>	<b>3.69</b>
<b>Dividend in EUR</b>	<b>0.20</b>	<b>0.25</b> +25%	<b>0.35</b> +40%	<b>0.50</b> +43%	<b>0.65</b> +30%	<b>0.85</b> +31%	<b>1.00</b> +18%	<b>1.20</b> +20%	<b>1.40</b> +17%	<b>1.65</b> +18%	<b>1.85</b> +12%
<b>Total assets</b>	<b>104.2</b>	<b>102.5</b> -2%	<b>100.5</b> -2%	<b>101.8</b> +1%	<b>106.1</b> +4%	<b>159.5</b> +50%*	<b>154.7</b> -3%	<b>160.8</b> +4%	<b>187.5</b> +17%	<b>187.20</b> -0%	<b>211.89</b> +13%
<b>Shareholders' equity</b>	<b>39.2</b>	<b>39.6</b> +1%	<b>40.6</b> +2%	<b>43.9</b> +8%	<b>51.3</b> +17%	<b>73.5</b> +43%	<b>80.2</b> +9%	<b>92.8</b> +16%	<b>85.7</b> -7.6%	<b>99.76</b> +16%	<b>104.91</b> +5%
Equity ratio	37.7%	38.6%	40.4%	43.1%	48.3%	46.1%	51.8%	57.7%	45.7%	53.3%	49.5%
<b># Shares in million</b>	<b>15.439</b>	<b>16.127</b> +4.5%	<b>16.306</b> +1.1%	<b>16.281</b> -0.2%	<b>16.351</b> +0.4%	<b>16.820</b> +2.9%	<b>16.783</b> -0.2%	<b>16.897</b> +0.7%	<b>16.769</b> -0.8%	<b>16.773</b> +0.0%	<b>16.908</b> +0.8%
<b>Headcount (FTE)</b>	<b>718</b>	<b>731</b> +1.8%	<b>759</b> +3.8%	<b>784</b> +3.3%	<b>821</b> +4.7%	<b>946</b> +15%	<b>948</b> +0.2%	<b>979</b> +3.3%	<b>1,031</b> +5.3%	<b>1,056</b> +2.4%	<b>1,095</b> +3.7%

\* Comparison 2019/18 distorted by first time application of IFRS16

 Content

<b>Management report</b>	2
Course of business 2024	20
<b>Statement of income</b>	27
<b>Balance sheet</b>	28
<b>Statement of cash flows</b>	29
<b>Development of shareholders' equity</b>	29
<b>Notes</b>	30
Segment reporting	30
<b>Auditor's report</b>	65
<b>Administrative Board report</b>	70
<b>Addresses</b>	72

**Dear reader,**

In 2024, M+M has laid a very good foundation for the future with high investments in our internal IT systems, the transition to the new Autodesk commission model as well as the development of our own software products.

Despite the associated burdens, we achieved almost consistently higher results in 2024 than in 2023, and a record cash flow of 369 Cents per share gives us enough room to increase the dividend by +12% to 185 Cents.

**Sustainably profitable strategy ...**

In the ten years since 2014 we generated a highly disproportionate net profit increase of +22% per year from a +8.9% p.a. gross profit growth by consistent cost discipline.

Furthermore, the annual growth in cashflow was +25% - the same is true for dividend, which has risen from 20 to 185 Cents in the 10 years since 2014 and thus will soon have increased tenfold.

**... will be continued in the future**

Also for the future, it is M+M management's clear goal to grow sustainably and profitably by consequent continuation of this strategy.

**Profit growth & full dividend distribution**

Consequently, our mid-term target is to double profit in 4-5 years - while maintaining the full dividend distribution policy, which we can afford because the lion's share of our software development expenses are booked as operating costs and not capitalized.

**Motto: Digitalization is sustainability**

Our business model is also sustainable, as it is consistently based on process optimization and the associated resource savings for our customers. Therefore the motto of M+M's 40<sup>th</sup> anniversary last year was 'Digitalization is Sustainability' - please read more about this topic on page 17.

Wessling, March 2025

Your M+M Group Management Board

**2024 at a glance**

- Group sales: EUR 325.84 mIn / +1.1%
  - M+M Software: EUR 109.32 mIn / +4.5%
  - M+M Digitization: EUR 216.52 mIn / -0.5%
- Record gross profit: EUR 174.59 mIn / +3.6%
  - M+M Software: EUR 99.03 mIn / +4.3%
  - M+M Digitization: EUR 75.56 mIn / +2.7%
- Operating profit EBIT: EUR 46.47 mIn / -0.8%
  - M+M Software: EUR 30.53 mIn / +7.5%
  - M+M Digitization: EUR 15.94 mIn / -13.7%
- Record net profit: EUR 30.49 mIn / +5.6%
  - Per share: 180 Cents (PY: 172)
- Record cashflow: EUR 62.32 mIn / +23%
  - Per share: 369 Cents (PY: 302)
- Dividend proposal: 185 Cents (PY: 165)
- Headcount Dec 31, 2024: 1,179 / +2.7%
  - Full time equivalent 2024: 1,095 / +3.7%

Adi Drotleff  
Founder/Chairman



Markus Pech  
Group CFO



Volker Nesenhoener  
CAD/CAM Software



Marcus Hoellrich  
Digitization Segment





# Group overview 2024

## Enterprise and market position

Mensch und Maschine Software SE (M+M) is a leading provider of technical software and digitization solutions in the CAD/CAM/CAE (Computer Aided Design, Manufacturing & Engineering) and PDM/PLM (Product Data / Lifecycle Management) and BIM (Building Information Modeling / Management) areas.

### 41 years at market, 28 years public

M+M was founded in 1984, and quickly developed into the leading European partner of today's CAD world market leader Autodesk. In 1997 M+M's IPO took place as one of the first issuers on the 'Neuer Markt'.

The M+M business model has since been going through a transition process which strengthened M+M's proprietary part and significantly improved scalability.

## Two Segments: Software & Digitization

The M+M business model is today based on the segments Software and Digitization (former name: VAR Business).

The M+M Software segment is developing standard software for the areas CAD/CAM, BIM/Engineering, Garden/Landscaping & CAE. Our CAD/CAM and BIM/Engineering software is marketed and sold globally to more than 70 countries, through our own subsidiaries, distributing partners and by export.

The Digitization segment develops tailor-made software solutions for customers in D/A/CH and several other European countries.

The segment's added value primarily comes from customer-specific adaptations, training and the Autodesk business, which actually contributes less than 25% to group gross profit (in 2001 this had been more than 75%).

*The two segment M+M business model:  
The Digitization segment has higher sales, driving the group's market share, while M+M Software is contributing more to gross profit and profitability.*

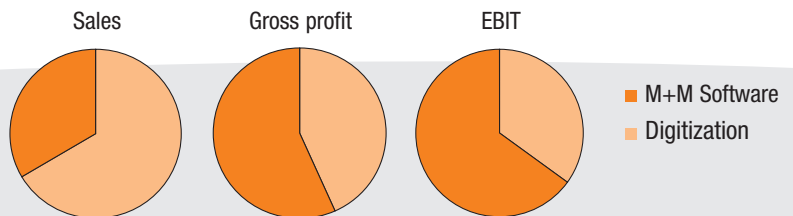
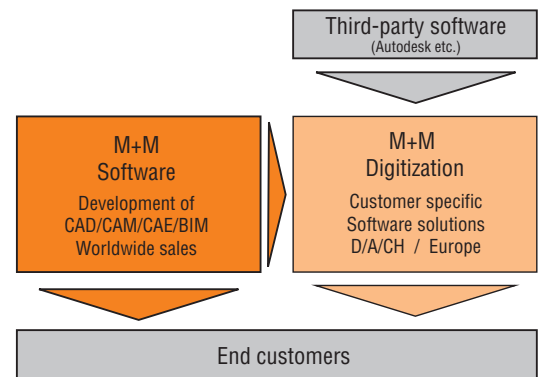



**Global sales with D/A/CH focus**

In 2024 the lion's share of EUR 325.8 mln sales was contributed by the D/A/CH region with 60.1% (42.5% Germany plus 17.6% Switzerland/Austria), while 30.9% came from other European markets. EUR 29.3 mln or 9.0% were achieved in Asia, North and South America, Africa and Australia with M+M's self-developed CAM and BIM/Engineering Software products - a EUR 2.8 mln / 10.4% surplus.

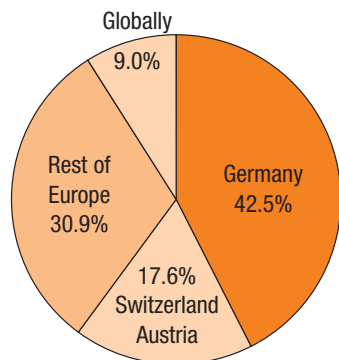

*With around 75 locations in 22 countries (colored darker here), the M+M group is one of the leading providers of technical software and digitization. Geographically, the D/A/CH region and Europe dominate sales, but in 2024 a noticeable EUR 29.3 mln or 9.0% were achieved globally, as M+M's self-developed CAM and BIM/Engineering Software is sold to over 70 countries.*

**Large customer and installation base**

Altogether, Mensch und Maschine's active installed base consists of far more than 100,000 CAD/CAM/CAE/PDM/PLM/BIM seats at over 30,000 end customer sites of all size categories - from small engineer's or architect's offices up to international large-scale enterprises.

M+M operates predominantly in the B2B (business-to-business) sector and only marginally in B2C (business-to-consumer).



# The M+M Portfolio:

## Digital twins by CAD/CAM/CAE/BIM/PDM/PLM

The extensive M+M portfolio consists of various digital twins, each of which maps complex 3D structures including associated metadata, across industries and segments for the areas of manufacturing, architecture/engineering/construction and infrastructure.

Some examples of such digital twins by M+M:

With the hyperMILL CAM software, the entire machining process can be simulated and optimized in a "virtual machine", which contributes significantly to the rapid amortization of our customers' very expensive precision machine tools (pages 6/7).

BIM - Building Information Modeling/Management: All disciplines of a building in 3D, including masses and cost dimensions as well as project timeline. With BIM Ready, BIM Booster and software solutions for Civil Engineering and Gardening/Landscaping/Earthworks, M+M is among the pioneers in this area (pages 8/9/10/12/13).

BIM for Infrastructure: M+M MapEdit connects geo and land register data with other data sources to digital city or factory twins, enabling any type of inquiry by internal or external users easily via the web (page 14).

And last but not least, many of M+M's manufacturing customers use PDM Booster, eXs or customX for digital twins in data management, CAE / plant construction or variant design, in order to significantly increase their productivity (pages 11-14).

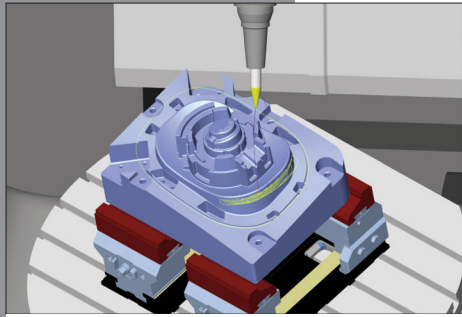

Virtual Machining in CAM: M+M's hyperMILL



BIM - Building Information Modeling/Management

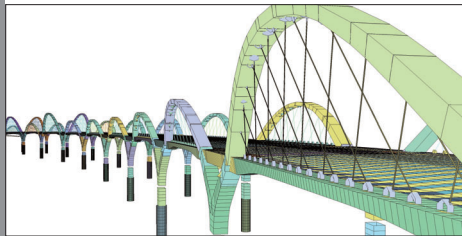

BIM in Civil Engineering: M+M SOFiSTiK Software



BIM for Infrastructure-Management: M+M MapEdit



Manufacturing: M+M PDM Booster, CAE/eXs, customX

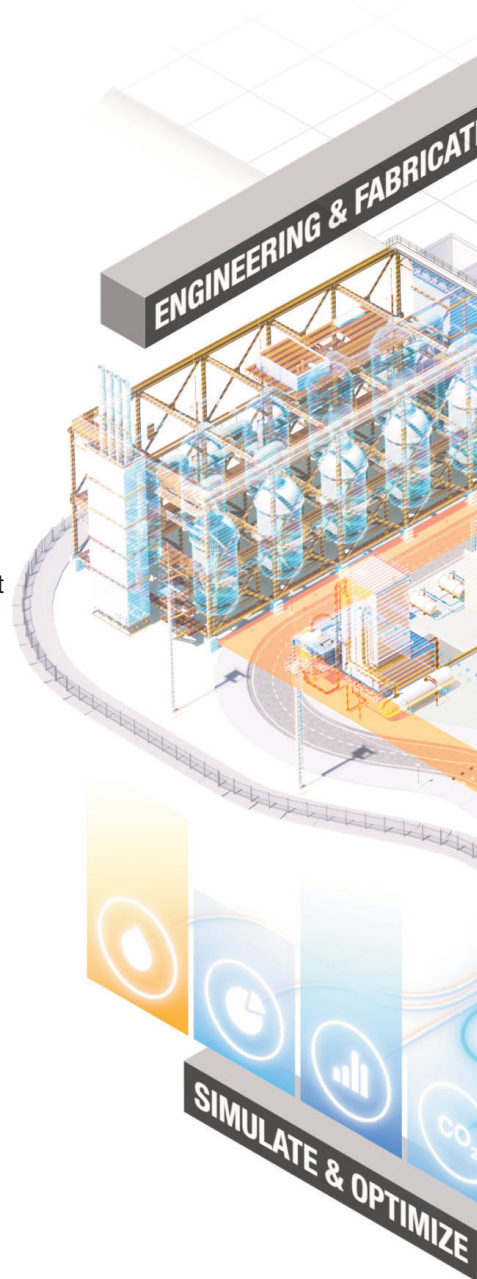



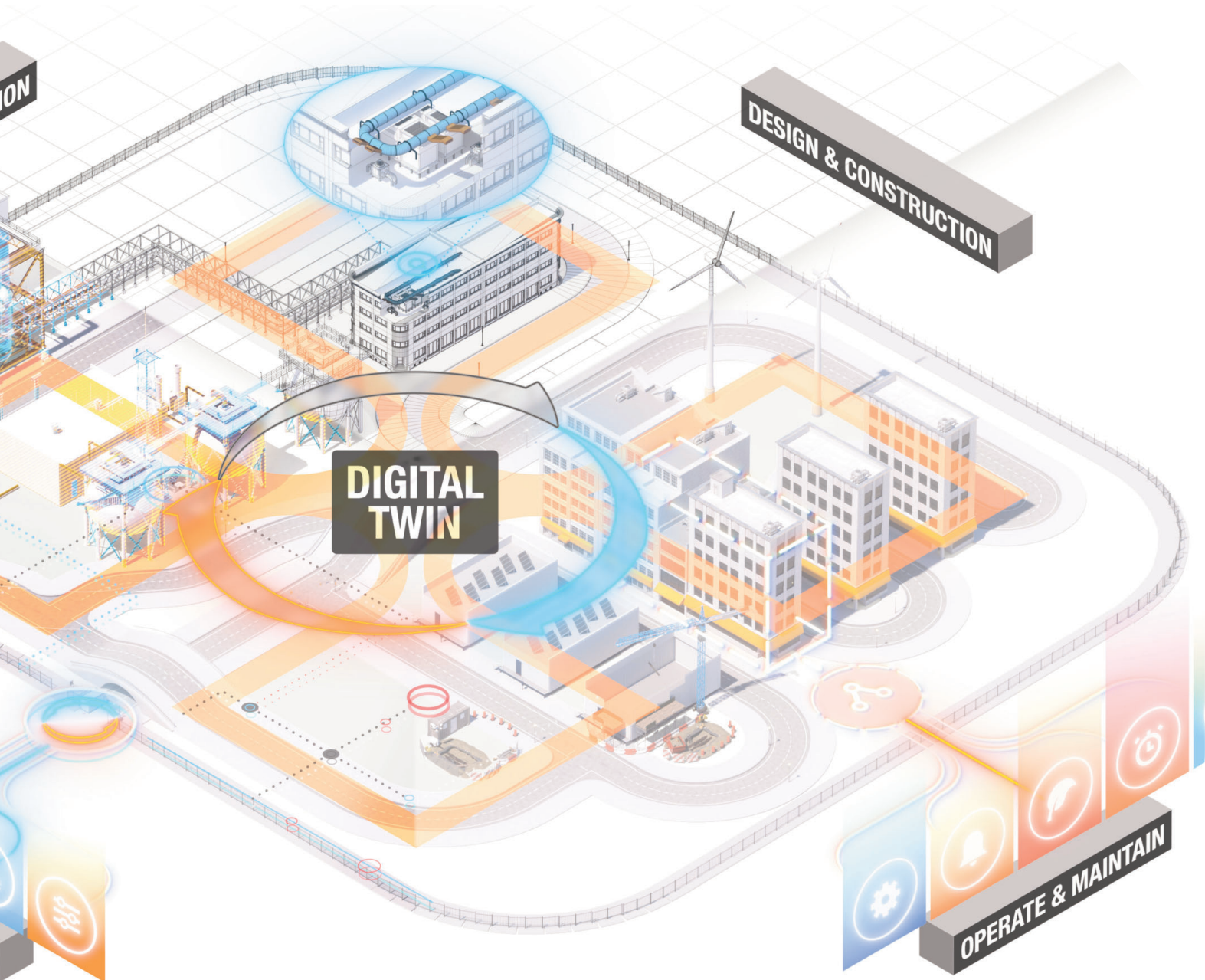

### The M+M segments in detail

The following pages give an overview across the Software and Digitization segments forming the actual M+M business model.

### Segment M+M Software

Economically, the M+M Software segment is a standard software developer with around 109 Million Euro sales (2024), more than 90% gross yield and solid 28% EBIT margin.

As a result, the segment pulls a relatively high added value from its just 33.5% share in group sales. In fiscal year 2024, nearly 57% of group gross profit and more than 65% of operating profit EBIT were achieved by the M+M Software segment.

### High development investment

M+M in 2024 spent EUR 26.7 mln or 24.4% of segment sales on maintenance and development of proprietary software.

### Roots in the 'Technology Offensive'

The roots of the Software segment originate in M+M's 'Technology Offensive' around the turn of the millennium, when we strengthened the proprietary added value by acquiring shares in CAD/CAM software companies.

The development since can be valued by the fact that the four companies today forming the segment had combined sales just above EUR 15 mln back in the year 2001, and had not yet reached break even.

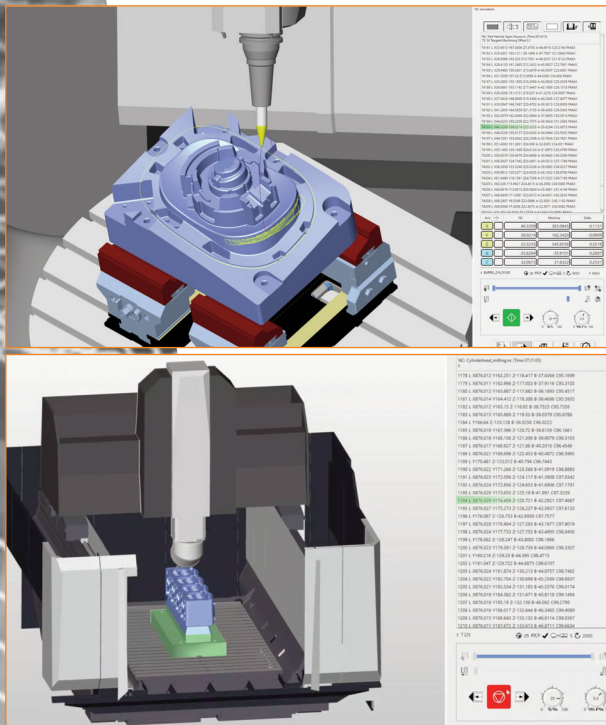

### Digital twin for CAD/CAM: Virtual Machining

Project: Simulate and optimize the entire machining process

Precision machine tools are available in very different designs and axis arrangements depending on the area of application, the required size and precision. For smaller to medium-sized parts, the clamped component is usually moved via two rotation axes, while the spindle can reach any point in the machining space via three linear axes (top picture).

For large, heavy parts, so-called gantry machines are used, in which only the milling spindle is moved via three linear and two rotary axes (bottom picture). For special cases gantry machines with up to 7 axes are in practical use. There are also combined turning/milling machines and many other special shapes.

With the VIRTUAL Machining technology in *hyperMILL*, the entire machining process can be simulated and optimized virtually. Not only are the exact kinematics of the machine tool used, but also the limits of all axes, the clamping device and the entire machining process are simulated.

With the help of this 'Digital Twin' it is possible to see in advance whether a part can be manufactured on a specific machine and in what time, whether the selected positioning fits or needs to be moved, and much more. The virtual simulation also can prevent real damage to the very expensive precision machine tools.





We push machining to the limit

Software solutions from the wholly owned subsidiary OPEN MIND are used on over 20,000 seats by over 10,000 customers globally for the process control of milling, drilling and turning in various industries such as mechanical engineering, tool, mold and die making, automotive, aerospace and shipbuilding, medical technology, as well as toy, watch, clock and jewellery manufacturing.

Particularly in the highly complex 5-axis milling process, the *hyperMILL* and *hyper-CAD S* product lines from OPEN MIND hold a technologically leading position and allow the customers quick payback of their high machine tool investments, which are typically in the six to seven digit range. This is the reason why Open Mind achieves EUR 30,000 per new *hyperMILL* license, a very high price for a standard software.

A variety of applications for specific products like tyre molds, turbine blades and impellers enable and simplify the programming of complex handling, lower the machining time and improve finished quality.

The product portfolio is rounded up by the innovative *millTURN* module for combined milling/turning machine tools and by the *hyperMILL MAXX* Machining package enabling enormous productivity gains by radical reduction of machining time.



### Shorter milling times due to intelligent machining strategies

Benefit: Significantly faster machining of complex parts

Customers: All users of precision machine tools worldwide

Time is money – this rule is particularly applicable for precision machine tools with purchase prices in the six or even seven digit range. *hyperMILL* significantly reduces milling times through intelligent machining strategies, pushing return on investment for these expensive machine tools to completely new dimensions.

E.g. a state-of-the-art rule so far said that for ‘Roughing’, the rough material removal in the first step, classical 3-Axis machines would be more suitable, while finishing could be better done using the more agile 5-Axis precision tools.

*hyperMILL* breaks through this rule by the ‘helical drilling’ method plunging the cutter into even hard materials in a staggering motion, without predrilling, enabling up to 5x higher material removal for roughing, even with less tool wear and cheaper cutters.

In combination with the *hyperMILL* method to accelerate finishing of flat surfaces up to 10x by using conical cutters with slightly convex curvature, the pictured lightweight aerospace part conventionally needing more than 10 hours machining time can be milled in just over 2 hours using *hyperMILL* - a five-folding of productivity !

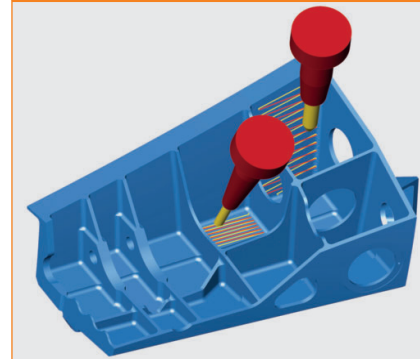
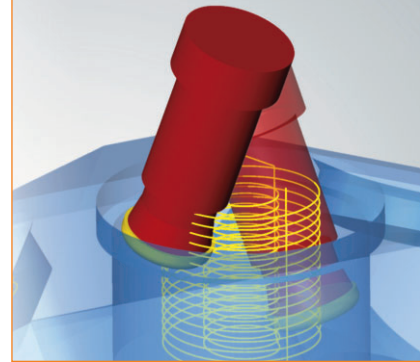

### High efficiency gains for Modelling and Prototyping

Benefit: From idea to reality in the shortest possible time

Customers: Manufacturers of innovative products e.g. Kärcher or Stihl

The goal in modelling and prototyping is to convert ideas into physical models and prototypes as quickly as possible. As the CAM software *hyperMILL* from M+M has particular strengths here, it is used by many manufacturers of innovative products.

E.g. Kärcher, the world’s leading cleaning equipment manufacturer located near Stuttgart, Germany. There are 600 to 800 prototypes per week, for which the CAD model comes in from the development department in the morning and the part should be ready in the evening. Since *hyperMILL*, including the underlying CAD software *hyperCAD S*, is programmed in-house with consistent user interfaces, it is no longer necessary to switch back and forth between several systems.

Another example: Stihl, the global market leader for chainsaws located nearby in Waiblingen, Germany. Thanks to the BEST FIT function in *hyperMILL*, parts produced in a 3D metal printer can now be quickly and precisely aligned on the 5-axis machine tool to remove support structures, which was previously time-consuming manual work.

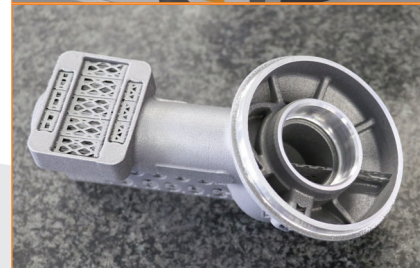
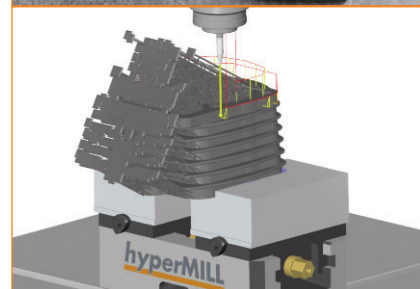



SOFISTiK is a leading technology provider of structural analysis and reinforcement software for Civil Engineering, particularly bridge, tunnel and construction design with impressive references around the world, for example the Sixth Street Viaduct in Los Angeles, USA, completed in 2022.

Over 3,000 customers in more than 60 countries on all 5 continents use SOFiSTiK Software to realise their projects - from reinforcement design for a family home up

to the analysis of large scale buildings and facilities, everything of course according to various international standards.

Special modules like the Bridge+Infrastructure Modeler to design Bridges, Tunnels and other profile buildings like noise barriers, a CFD module for wind analysis (see Arnulf-park bridge on next page), or functions for seismic analysis of building safety in case of earthquakes are completing the portfolio.

SOFISTiK was founded in 1987 and in 2000 joined the M+M group, which has held a majority stake since 2019, currently 51.4%.



Sixth Street Viaduct, Los Angeles, USA / Customer: COWI North America

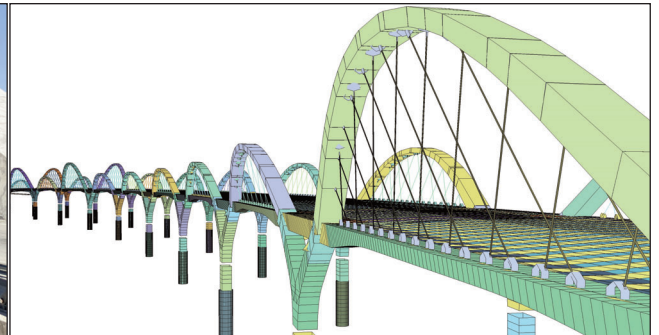

SOFISTiK BIM Computer Model

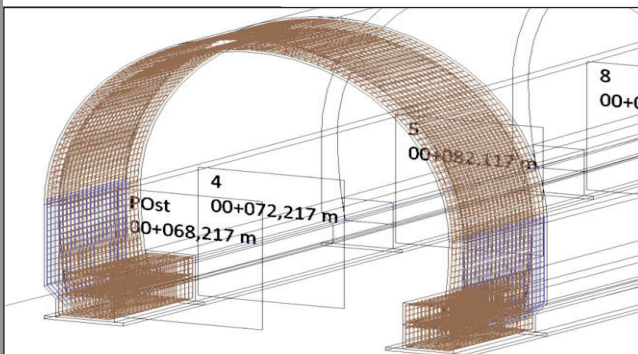

SOFISTiK Bridge + Infrastructure Modeler: Tunnel Reinforcement

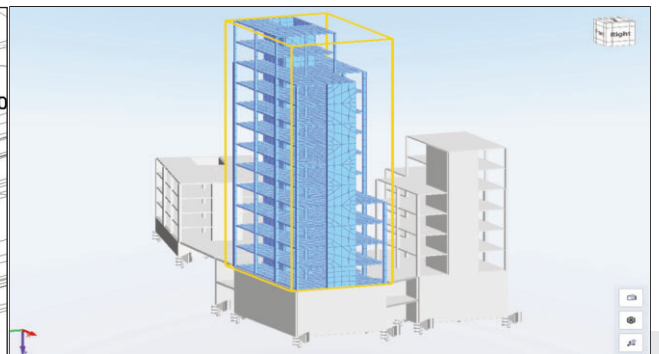

SOFISTiK Seismic Analysis



**CAD in practice: Structural and dynamic analysis of bridges**

Project: Arnulfpark bridge for pedestrians and cyclists in Munich

Customer: SSF Ingenieure, Munich, Germany

The foot and cycle bridge at Arnulfpark, completed at the end of 2020, over the 240 meter wide platform forecourt of Munich Central Station, spanning 37 tracks, was extremely challenging for design, construction and calculation.

In order to disrupt rail traffic as little as possible, the steel bridge structure was pre-assembled on-site and pushed in over the piers in an incremental launching process into its final position (pictures on the right).

SOFiStiK software from the M+M Group was used for the structural and dynamic calculations of the very complex bridge geometry. Particularly critical were the incremental launching phases (picture mid left) and the calculations of the vibration behavior under strong wind influences, where the CFD method (Computational Fluid Dynamics) was used to prove by computer simulation (picture mid right) that the expensive installation of vibration dampers was not necessary.

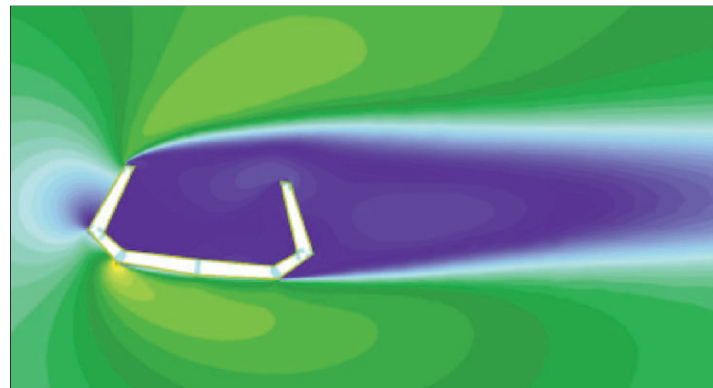
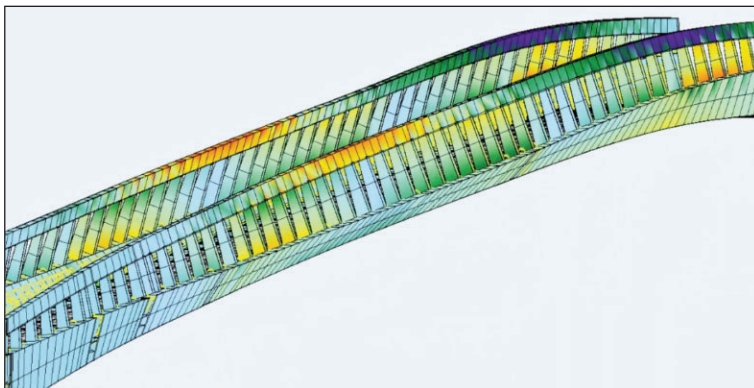

Photocredits: Hans Gössing (1/2), SSF Ingenieure (3/4/5)

## DATAflor



DATAflor has a strong position in the German-speaking gardening and landscaping market. The proffered solutions not only contain a graphical planning section but also tools for complete financial calculation and billing of such projects. DATAflor was founded in 1982 and in 1999 joined the M+M group, which has held a majority stake since 2002, currently 67.2%.

DATAflor software specializes on the organic forms, the special structures and the core competencies of landscape architects' offices as well as gardening and landscaping enterprises. Any functionality is focussed on the plants and the landscaping. Recently DATAflor software is also available for earthworks and civil engineering.

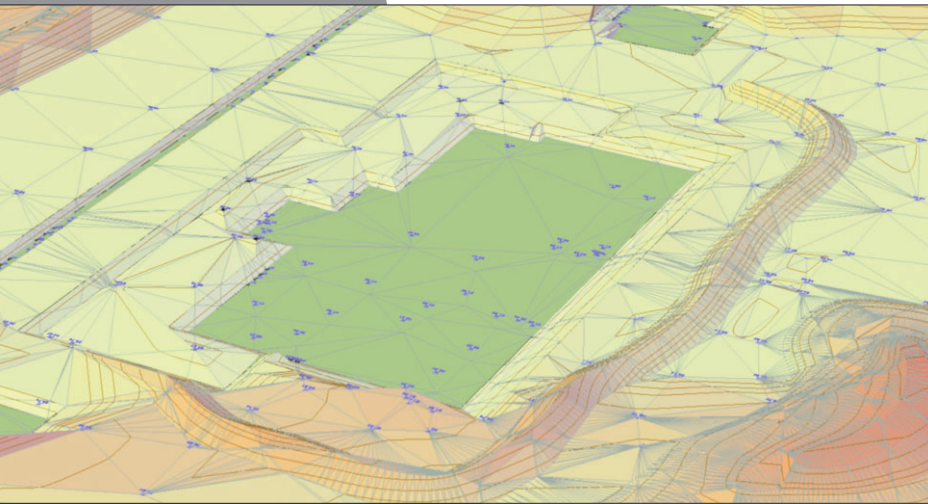

*Two examples from the extensive DATAflor Software functionality:*

*The 'Digital Terrain' module enables convenient 3D terrain design and calculation of excavation and filling material for different landscape variants. The software can not only read terrain data from 3D scanners or drone cameras but also output 3D terrain data to automatic excavator machine control units.*

*Not only does this improve quality and efficiency of excavation and earth moving work significantly, but also relieves the increasingly urgent shortage of skilled workforce in the construction industry, as it firstly improves the attractiveness of the job in the excavator cab especially for younger and technology-savvy people, and it secondly saves the previously obligatory 'second man with the yardstick' on site.*

*The GRUENSTUDIO 3D module creates a live representation of the planned garden on screen or via VR glasses, thanks to an extensive plant catalog and the 'flowering calendar' across the seasons. The time of day is also selectable, in order to show the customer different sun angles or the effects of lighting concepts by night.*





# eXs

THE FUTURE OF CAE

In 2020 M+M introduced eXs, a brand new CAE software (Computer Aided Engineering) redesigned from scratch, fully data compatible and largely user interface compatible to its predecessor eccscad, proven since 1993, easing the transition for all existing users.

eXs introduces completely new CAE project concepts for the Industry disciplines of electrical and process engineering, hydraulics and pneumatics as well as for all building services disciplines in BIM projects. With its high performance database, increased functionality, simplified usability and free configurability, eXs defines new standards for CAE software.

As eXs is based, like eccscad, on the globally market-leading Autodesk standards, it is easy to fulfil the ever-increasing demand for cross-trade projects both from Industry (Mechatronics) as well as from Architecture and Construction (BIM).

eXs is developed by the 100% subsidiary M+M Mechatronik GmbH belonging to the Software segment. Sales, training and customization are largely taken care of by CAE/Manufacturing and BIM/Architecture teams in the Digitization segment and to a lesser extent by external partners.



*The new eXs can be used in CAE project concepts for the Industry disciplines of electrical and process engineering, hydraulics, pneumatics or mechatronics as well as for all building services disciplines within BIM projects.*





### Segment M+M Digitization

With approx. 50 locations and over 500 employees in Germany, Austria and Switzerland as well as in UK, Italy, France, Poland, Romania and Hungary, M+M Digitization provides full area coverage and serves approx. 20,000 customers with interdisciplinary solutions and at the highest quality.

### Dynamic growth

The segment emerged in 2009 from the Autodesk Distribution (wholesale), which had previously been in operation for 25 years.

The transition was supported by acquisitions of sales partners and the divestment of the distribution rights, so that the 2009 sales of EUR 35 mln was more than sixfold in the following 15 years to EUR 217 mln in 2024, with 7.3% segment EBIT margin.

### High proprietary business contribution

Gross profit in the M+M Digitization segment is made up from proprietary M+M business (e.g. customizing, own software, training, support) and by reselling third-party software from Autodesk and other providers.

### Growth drivers: Training ...

The growth in proprietary business in the past years was based on increased demand for training in the sectors Construction and Manufacturing, where M+M has created the two training series BIM Ready & CIM Ready (CIM: Computer Integrated Manufacturing) - see also the cover story of this report.

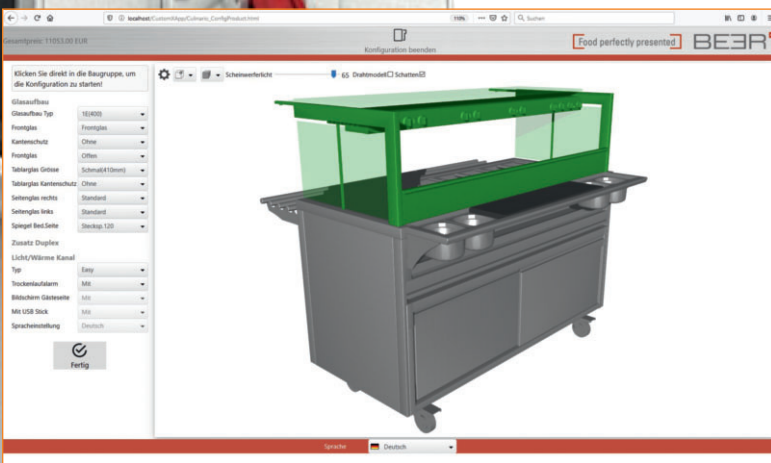

### Digitization in practice: Fully automated variant design

Project examples: Electric distribution boxes and Gastronomy showcases  
Customers: Bals Elektrotechnik, Germany and Beer Grill AG, Switzerland  
M+M's configuration software customX enables up to 90% productivity improvement by automated variant product design of any complexity. After Web entry of customer requirements, all necessary calculation and production documents are generated automatically and correctly.

Example 1: Bals Elektrotechnik configure individual customer specific electric distribution boxes, including an interface to their ERP system SAP HANA.

The internal workflow from offer through order entry to production has been accelerated to the extent that even single-item production is absolutely economical.

Example 2: At Beer Grill AG, where all possible combinations can be selected for each product line, from the size of the showcase to temperature control and lighting as well as the color of the decor. customX immediately checks whether the entries are plausible and generates dimensional drawings, visualizations, design drawings, bill of materials - in short, everything that is initially required for the offer and later for production.









**... and digitization projects**

The second growth driver are customer specific digitization projects, in which standard software modules are connected to individually tailor-made project solutions, adding functionality where necessary.

In order to avoid re-inventing the wheel in each project, M+M has developed a growing library of application software and content to adapt the Autodesk product portfolio, which is developed for global use, to the specific requirements in Germany, Austria, Switzerland and other European countries, e.g.:

- Data management for Industry 4.0  
**pdm**  **booster**
- Solution for Architecture/Construction  
**bim**  **booster**
- Digital factory/city / BIM for Infrastructure  
**map**  **edit**
- Variant design/configurator software  
**custom**  **X**

M+M's customer specific projects can range from few man-days to several man-years. Large projects are usually cut into several segments. Project development altogether contributes a significant share to service gross profit in the Digitization segment.

To provide optimal professional consulting quality to customers from different sectors, the M+M Digitization segment organisation has competence teams for Manufacturing, Architecture/Engineering/Construction (AEC) and Infrastructure. On our local Websites there are a lot of interesting reference stories about customers and projects from these teams. Four examples are displayed here and on the next page, in short.

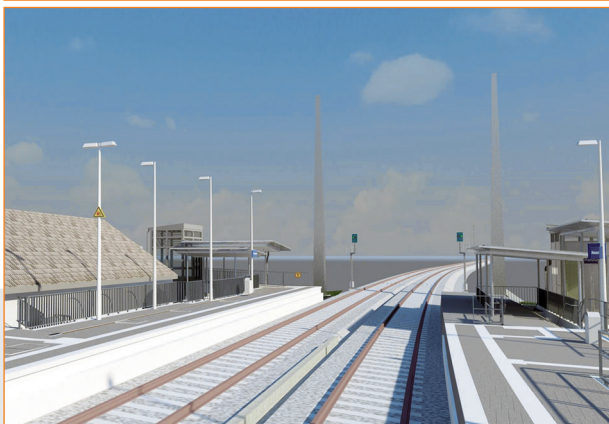

**Digitization in practice: Building Information Modeling/Management (BIM)**

Project: BIM introduction and training for a large railway operator

Customer: Deutsche Bahn AG, Berlin, Germany

All disciplines of a building, including time and cost dimensions, working together in 3D, collaborating, and sharing information via a common database, that's BIM. Due to the holistic approach of this new method, high time and cost savings can be achieved in all phases (Planning, Construction, Operation).

Deutsche Bahn AG is one of the BIM pioneers in Germany, continuously working with its subsidiaries to improve their standards. After a pilot phase lasting several years, the BIM method is now used in all new projects.

M+M has been a DB partner with the BIM Ready training program for years and organizes information forums for planning and project employees such as the DB BIM Messe in Berlin. Some DB departments and many external DB partners are using M+M's BIM Booster in planning, quantity takeoff and model checking, as well as the engineering software from M+M Group member SOFiSTiK in the areas of bridge design and calculation.



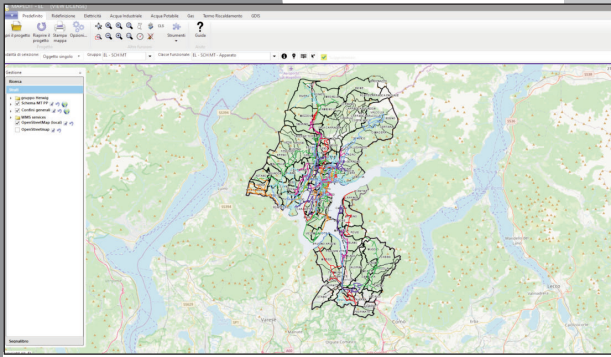

Customer: Stadtwerke Lugano (AIL), Switzerland

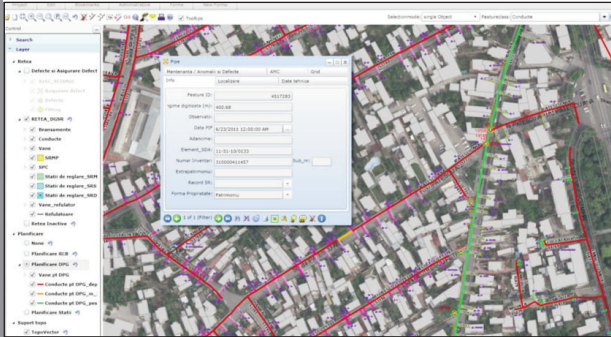

Customer: Engie Romania SA, Romania

# mapedit

## Digitization in practice: BIM for Infrastructure

Projects: M+M MapEdit as a data hub for the Digital City or Factory

Customers: Municipalities, Suppliers, Industry, Ports/Airports, Planning Offices...

M+M's Infrastructure software MapEdit is used on approx. 2,500 seats by nearly 200 customers in Germany, Switzerland and other European countries to connect geo and land register data with other data sources to digital city or factory twins, enabling any type of inquiry by internal or external users easily via the web.

Specialist applications like area or development plans, tree or property cadastre, land value calculation, electricity, gas, water, waste water, telecommunications, district heating, plant topography, emergency management, incident documentation etc. are available. Thousands of users can access the MapEdit data hub at the same time, no matter whether from specialist departments, for citizen information via the web or by mobile maintenance technicians on site.

Further Information: [www.mapedit.de/en](http://www.mapedit.de/en)

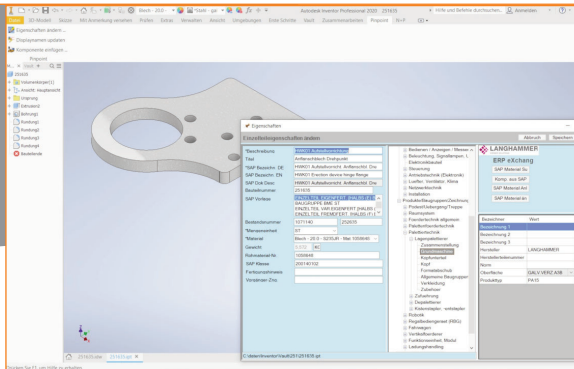
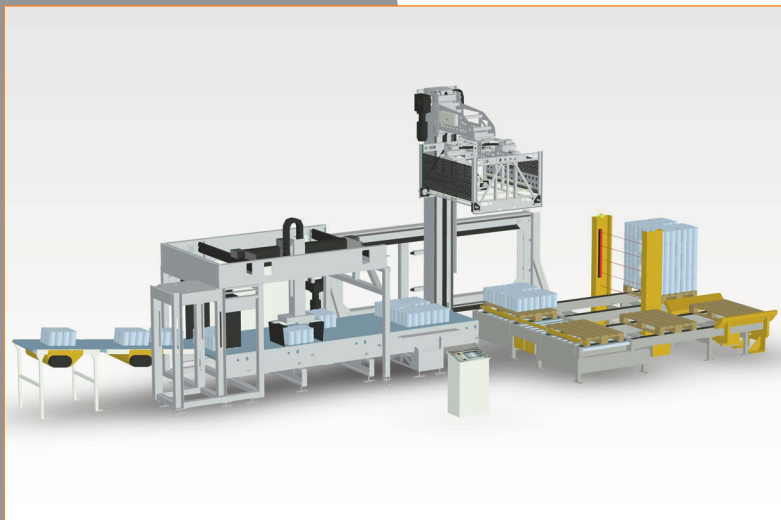

# pdm booster

## Digitization in practice: Product Data Management (PDM)

Project: Connecting design data and commercial information

Customer: Koerber Supply Chain GmbH, Eisenberg, Germany

Connecting design data and commercial information is a standard request from our industry customers, however with very individual challenges and complexities depending on the situation. Therefore M+M developed the product line PDM booster, which is currently in use in thousands of customer seats.

For example at Koerber Supply Chain GmbH, a manufacturer of special machines for intralogistics and palletizing technology, who sought help from M+M to streamline their own design processes.

Today, the PDM booster links the CAD systems with SAP. Media breaks between design, work preparation and purchasing have been eliminated, and many automatic functions make work easier. Conclusion: The employees are very satisfied, the data quality has been significantly improved and the time for material master creation and maintenance in SAP has shrunk by half.



**Allocation of gross profit**

In the year 2024 Mensch und Maschine achieved 56.7% of value added metric gross profit in the Software and 43.3% in the Digitization segment, distributed over many different sectors across the manufacturing, construction and infrastructure industries.

**Manufacturing generates approx. 55%**

Manufacturing continued to account for the largest share of the EUR 174.6 mln gross profit achieved in 2024 at around 55%, divided into the following two blocks:

**Largest block: M+M's CAD/CAM software**

M+M's own *hyperMILL* CAM software (in the diagram on top), together with the CAD core *hyperCAD S*, also developed in-house, forms the largest value-added block. The target group here are all owners and buyers of precision machine tools globally.

**Longest tradition: Digitization Manufacturing**

The tradition of our Manufacturing (MFG) team in the Digitization (formerly VAR) segment goes back to the founding of M+M. The focus: training (CIM Ready) and digitizing projects based on eXs, customX, PDM booster for customers in Mechanical/Electrical and Process Engineering, Automotive/Aerospace/ Shipbuilding, Mold/Tool Making, Hydraulics, Pneumatics (left sector in the diagram).

**Architecture/Construction approx. 35%**

Architecture/Construction, with around 35% gross profit share the second-largest area, is also divided into one block each from the Software and Digitization segment:

**M+M Software: DATAflor and SOFiSTiK**

DATAflor is aimed at architects and contractors in gardening, landscaping and earthworks, primarily in the D/A/CH area, while SOFiSTiK globally supports planners and construction companies in civil engineering, bridge, tunnel and building design (right sector).

**The BIM professionals: Digitization AEC**

The Architecture/Construction/Engineering (AEC) team with its BIM professionals takes care of digitization (BIM booster) and training (BIM Ready) for structural and civil engineering, building services and facility management customers (bottom right).

**Around 10% hybrid: MFG & AEC**

An estimated 10% of gross profit is not directly attributable to MFG or AEC, but is hybrid in between. Infrastructure with Map-Edit contributes here, but also CAE with eXs and variant design with customX as well as the area of construction suppliers from manufacturing is allocated here (bottom left).

**Common Base: Autodesk standards**

Except for CAM, most M+M solutions are based on CAD standards from Autodesk, primarily AutoCAD, Revit, Inventor and Vault. This light blue field in the diagram stands for the part of group's gross profit generated (across all sectors) by Autodesk margin or commission in the Digitization segment. In the Software segment, license payments to Autodesk are cost of materials.

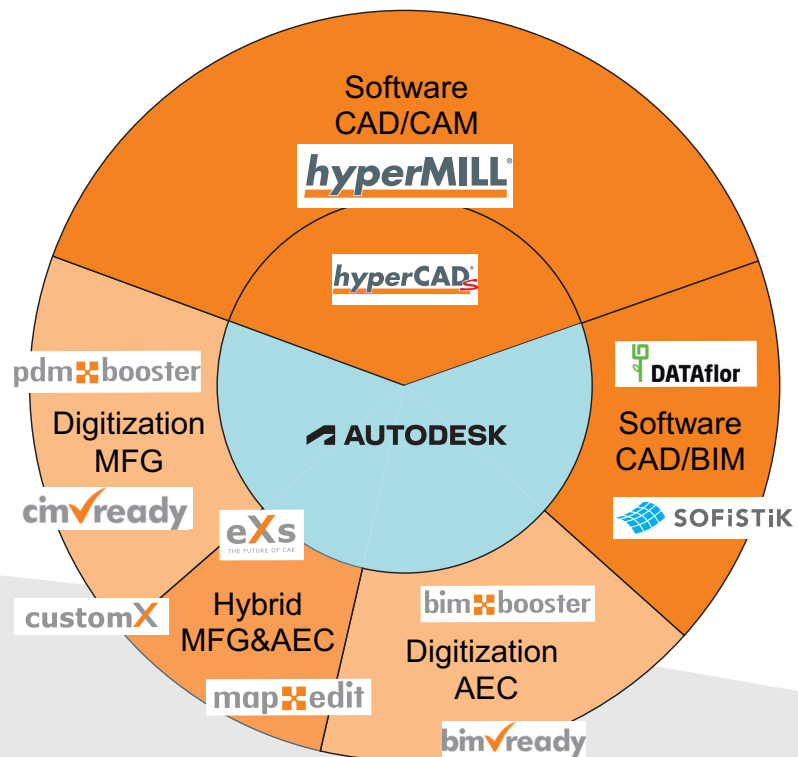

**Ecology and Economy in harmony**

Probably the most effective contributions to the reduction of global CO<sub>2</sub> emissions are, on the one hand, energy savings and, on the other hand, replacing fossil-based power generation with regenerative ones.

Both methods also have the advantage that they not only make ecological sense, but also deliver direct economic return.

That is why Mensch und Maschine has been active on both paths for a very long time.

**M+M as a regenerative power producer ...**

We are using all suitable roof surfaces in corporate ownership for regenerative power production, totalling approx. 200 MWh p.a.

As early as 2011 M+M's first photovoltaic plant had been installed on the roof of our Training Center in Wiesbaden.



The new SOFiSTiK building in Nuremberg with solar+geothermal and the new DATAflor Technology Center in Goettingen with solar plus cogeneration unit followed in 2019/20.

In September 2021, an approx. 1,500 square meter photovoltaic system was installed on the roof of M+M headquarters in Wessling.

As replacing coal-fired by solar electricity saves around one kilogram CO<sub>2</sub> emissions per kWh (Source: strom-report.de), M+M thus is achieving approx. 200 metric tons of CO<sub>2</sub> savings per year. Moreover, ecology and economy are in full harmony: The new power plant on the headquarters roof will have amortized after approx. 10 years.

**... compensates 6.5% of CO<sub>2</sub> footprint**

As a pure think tank with nearly 1,100 employees (full-time equivalent), M+M does not have a very large CO<sub>2</sub> footprint: Assuming around 7 tons of CO<sub>2</sub> per head & year and a professional/private distribution of 40/60%, the annual total is approx. 3,070 tons of CO<sub>2</sub> for the M+M group.

Thus we compensate approx. 6.5% of our CO<sub>2</sub> footprint by regenerative power generation.

*The 1,500 square meters photovoltaic system on the roof of M+M headquarters in Wessling takes up the entire useful roof area and has been supplying green electricity since October 2021.*



**The M+M business model is based on resource savings for customers ...**

A much greater effect is generated at the level of M+M customers - through our business model, which is consistently based on process optimization and the associated savings in resources:

A precision machine tool that runs two to five times faster consumes correspondingly less electricity (see pages 6/7).

The same applies when customers accelerate their technical processes with eXs, customX or PDM Booster (pages 11/12/14).

Or when BIM Ready training and the use of BIM Booster enable more effective planning and resource-saving construction (page 13), or when large infrastructure operators can achieve their ambitious sustainability goals more quickly through MapEdit (page 14).

A structure planned and calculated with SOFiSTiK software uses less steel and concrete or can alternatively be made of a more environmentally friendly material such as wood (pages 8/9).

And with the Gardening/Landscaping design software from DATAflor, gardens or parks are created that make a direct contribution to CO<sub>2</sub> reduction (page 10).

It can therefore be assumed that the main motivation of M+M customers is to save resources with the help of our technical software and digitization solutions - hence a direct correlation between the turnover of the M+M group and CO<sub>2</sub> footprint reduction of our global customers is likely to exist.

The level of this correlation certainly cannot be quantified exactly, but it can be estimated approximately based on customers' electrical energy savings:

Assuming an electricity price of 25 cents per kWh and CO<sub>2</sub> emissions of 250 grams per kWh (estimated average values for our customer/country mix), one million Euros less in electricity expenses corresponds to 1,000 tons savings of CO<sub>2</sub> emissions.

**... which should be enough to more than compensate the M+M CO<sub>2</sub> footprint**

In relation to M+M's approx. 3,070 tons CO<sub>2</sub> footprint, this means:

If our customers save only EUR 3.07 million in electricity costs by using our software (that would be below 1% of the M+M turnover), we are already CO<sub>2</sub>-neutral.

Realistically, a significantly higher savings rate can certainly be assumed for our customers, moreover since the above calculation only refers to electrical energy and all other resource savings would have to be added.

*The significant reduction of machining times by M+M's CAM software goes hand in hand with accordingly less power consumption (and tool wear). Good for the machine operator - and the environment.*



**Digitalization is Sustainability:** The environmental protection practiced by M+M through digitalization does not cost customers any additional money, but on the contrary reduces costs and thus fully balances ecology and economy.

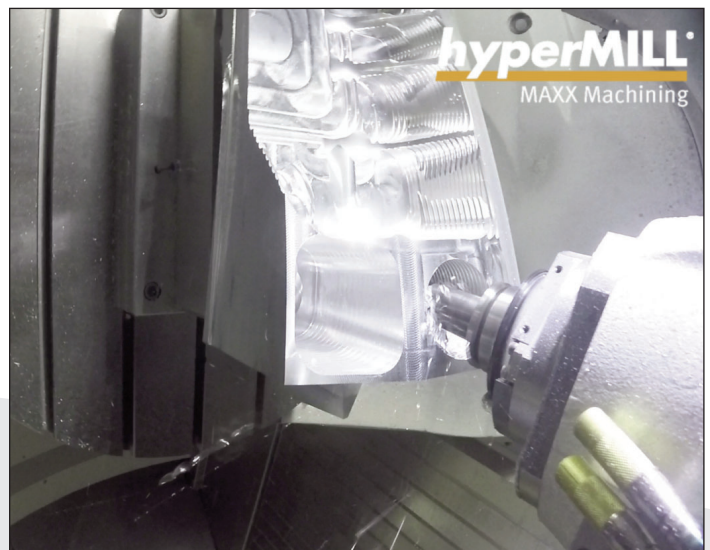

Workforce (FTE)

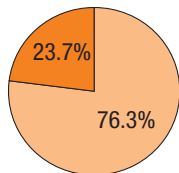

Management

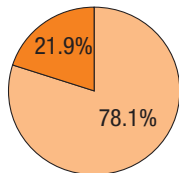

Admin Board

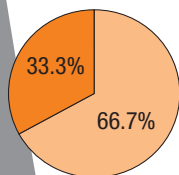

- Female
- Male

**Group headcount just rose moderately**

Group gross headcount at Dec 31, 2024, was 1,179 persons (PY: 1,148 / +2.7%). The average full time equivalent (FTE) 2024 climbed to 1,095 (PY: 1,056 / +3.7%), with 570 / 52% (PY: 547 / 51%) in Software and 525 / 48% (PY: 509 / 49%) in Digitization.

**Industry-typical gender quota**

The proportion of women is 26.6% (gross) or 23.7% (FTE). This reflects the unfortunately very weak supply of female specialists in technical professions and the significantly higher share of part-time female employees. Nevertheless, M+M has a female proportion of 21.9% in the management teams.

**Employees are co-entrepreneurs**

Traditionally, there is a very high focus on good corporate culture at M+M. During the 41 years since foundation, our employees were always seen as 'Co-Entrepreneurs' and fully integrated in the decision making process.

Whenever acquiring companies in and outside Germany in the course of the intensive expansion since IPO in 1997, M+M always cared for and respected the specific culture of the companies acquired.

The decision making structures in the M+M group are as decentralised as possible. The individual entities have a high degree of autonomy in order to be able to optimally meet the customers' requirements and to achieve the best possible results in the individual markets.

**Experienced management team**

This corporate culture generates a high degree of continuity. Staff turnover in the M+M group is very low, which even during the hype phases of the IT industry prevented a drain of qualified specialists from which other similar companies in IT suffered. As a result, M+M has an experienced management team down to the second and third management level, with team members mostly looking back on an employment period of more than 15 years.

**Apprenticeship and qualification: Approach vs. shortage of skilled workforce**

M+M offers apprenticeship and is very active in employee qualification. In addition, there are cooperations with local universities and colleges at many locations. In this way, we increase our attractiveness as an employer and actively counteract the lack of skilled workforce that is also latent in our industry.



*Boubacar Likeng started working for M+M in Paris in 1998. Since 2012 she has been head of M+M France.*





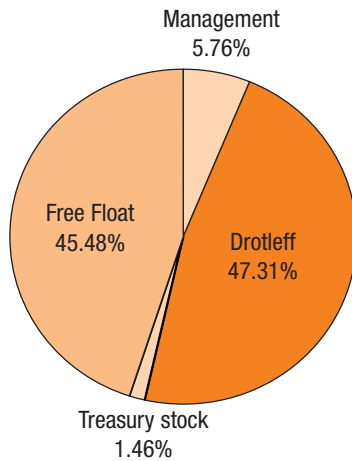

### Entrepreneurial and public company

Though M+M shares have been listed on the stock market for 28 years, a large portion of the shares are still in the hands of the management. Founder Adi Drotleff held 47.31% on Dec 31, 2024, other management members held further 5.76% of shares.

### Trading under 'European SE'

In 2006, the parent company was converted from AG to SE. In parallel, a structure with M+M SE acting as pure finance holding was realized. Central group functions are executed by the subsidiary M+M Management AG, while all operating business is performed by German and international subsidiaries.

Due to the founder's controlling interest, a 'monistic' instead of the dualistic AG board structure was chosen for M+M SE, which, from a corporate governance point of view, is much better suited for an owner-managed and at the same time public company.

### Monistic SE board structure

In the Administrative Board, combining the AG's Advisory Board ('Aufsichtsrat') functions with those of an administrative body ('Organ'), Drotleff holds the controlling majority together with his wife Heike Lies, while Dr. Rupprecht von Bechtolsheim as independent member represents the interests of free shareholders.

The Board of Managing Directors ('Geschäftsführende Direktoren'), equalling the 'Vorstand' of a German AG without being a legal body ('Organ'), consists of Adi Drotleff and CFO Markus Pech (Group finance and admin).

### The founder as an 'active' Chairman

Since Jan 1, 2023, Drotleff is at his own request only simple member of the board of directors with reduced remuneration, since he had largely withdrawn from daily business from 2019.

As an 'active Chairman' he concentrates on Group Strategy and Communications.

### Control by Group Management Board

More than 10 years ago, Drotleff had set up the Group Management Board staffed by the Managing Directors and the heads of the large operating units.

In addition, other members of the upper management levels take part in the regular board meetings as required.

### Listed in scale and m:access

The M+M share is listed in the premium SMB segments scale of Frankfurt stock exchange and m:access of Munich stock exchange.

Both segments prescribe, for admission, consequential duties above and beyond legal requirements, guaranteeing a high degree of transparency. In M+M's view, they are ideal market segments for achieving a reasonable cost-benefit ratio of a stock exchange listing in relation to the market capitalisation, protecting the legitimate interests in transparency of the shareholders.

Due to the requirements for disclosure and transparency these market segments represent fully operational markets with protective mechanisms that are very close to that of the regulated market and that guarantee the marketability of the shares including the tradability through Xetra.

In addition, M+M is highly overfulfilling the scale and m:access rules by publishing full quarterly reports and German/English IFRS reporting.

## Risks and Opportunities

The operations and activities of the M+M group are subject to various risks.

In our risk management system, sources of uncertainty are systematically identified, documented, evaluated and as far as possible controlled.

In all business units there are so called risk owners, responsible for the description, evaluation and control of risks in their fields. All units' risks are documented in a risk inventory together with the initiated counteractions, and the remaining risk is evaluated. The evaluation takes into account the likelihood of occurrence and the impact on the group.

The risk inventory with its documentation of counteractions, together with the monitoring of various early indicators, allows control of the development of a risk. The reduced risk impacts and likelihoods of occurrence after successful counteractions, are duly monitored and reported to the Managing Directors.

The remaining risks, particularly, are taken into account in business planning.

The accounting is integrated into the risk management, which allows identification and evaluation of risks which are in conflict with the compliance of the group financial statements. At this stage, we cannot see any such risks.

The whole accounting is subject to efficient control mechanisms. These particularly include extensive monthly reporting and liquidity planning, which are controlled in detail. Additionally, there is a regular review concerning specific items.

In addition, the financial transactions are supervised continuously. Within finance and accounting, there is additional protection by the principle of dual control. Systematic limit controls (e.g. for open sales orders or for capital expenditure invoices) supplement the control mechanisms.



**In detail, the following risk categories exist:**

**Credit risks:**

Bad debt risks are counteracted with customer credit insurance, individual bad debt provisions, and streamlined receivables management.

Also favourable in this respect, is the fact that sales are divided among many individual customers each of which carries less than 1% of the total group revenue.

**Warehouse and transport risks:**

The risk of loss in value during warehousing can be considered low due to very low stock level and fast turnover.

Transport risks are generally covered by corresponding insurance contracts.

**Sales and market risks:**

As with every other supplier of standard software, M+M is subject to software market and product cycles, especially those of the CAD/CAM market. Such risks are generally counteracted, as far as possible, by the vertical and regional division of the M+M Group and by the spread across several product lines, but risk may not always be fully compensated by these actions.

**Personnel risks:**

As an enterprise in the software industry, M+M is, in principle, dependent on individuals with special skills.

M+M's distinctive corporate culture, so far, has been instrumental in keeping employee turnover exceptionally low.

The risk of dependence upon key top management people has been counteracted by appointing several Managing Directors and by strengthening the secondary management level.

**Supplier risks:**

Concentration on the main supplier Autodesk represents a certain risk through dependency on this supplier's product development, market competence and operational policy.

**Losses at subsidiaries and shareholdings:**

In all shareholding or subsidiary relationships, it is recognised that there is a risk that, contrary to positive expectations, a negative development may occur possibly proceeding to total loss.

This would cause an appropriate impairment of goodwill or investment value.

**Financing and liquidity risk:**

As in any business model not exclusively financed by equity, there is a dependency risk for the debt financed part due to the refinancing capabilities of the financial market. This risk is counteracted by distribution of credit lines at several banks inside and outside Germany. It cannot be excluded, however, that the refinancing interest rate payable by M+M may develop negatively or the refinancing by debt may fail in parts or in total. Due to the positive balance sheet development in recent years, M+M now has a net liquidity surplus, so this risk has become less important.

**Cyber risks:**

Like any other company, M+M is exposed to various cyber risks, which are countered with a bundle of measures. This includes, in particular, securing critical data sets, ongoing training and raising awareness of all employees about the topic of cybercrime and much more.

Opportunities result from the successful execution of our general strategic concept. These are detailed in the 'Outlook' section.



**Revenue & Gross profit (in million EUR)**

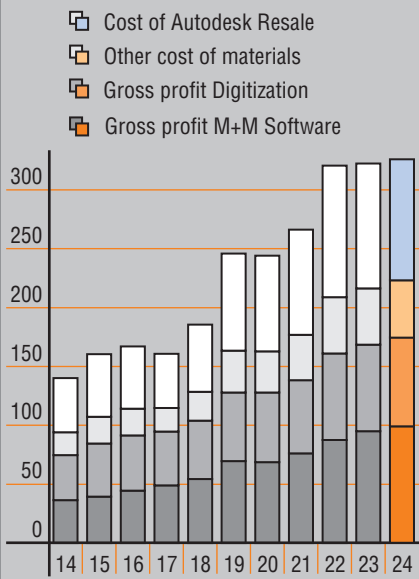

**Earnings (in million EUR)**

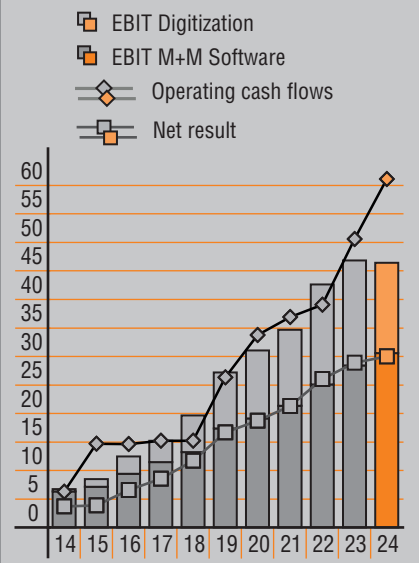

**Course of business 2024 and situation of the group**

In 2024, M+M has laid a very good foundation for the future with high investments in our internal IT systems, the transition to the new Autodesk commission model as well as the development of our own software products. Despite the associated burdens, we almost consistently achieved higher results, and a record cashflow allows to raise the dividend, which due to +25% growth rate p.a. in the 10 years since 2014 is close to tenfolding.

**Autodesk transition effecting sales**

Group sales came in at EUR 325.84 mln (PY: 322.31 / +1.1%) with EUR 109.32 mln (PY: 104.63 / +4.5%) from M+M Software and EUR 216.52 mln (PY: 217.68 / -0.5%) from Digitization. Without the technical effect of Autodesk's switch from resale to commission, sales would have been c. EUR 26 mln higher.

**Record gross profit +3.6% above PY**

Gross profit climbed to record EUR 174.59 mln (PY: 168.53 / +3.6%), with EUR 99.02 mln (PY: 94.95 / +4.3%) from M+M Software and EUR 75.57 mln (PY: 73.59 / +2.7%) from Digitization. The Autodesk transition lifted gross margin in Q4 to 70.9% (Q1-Q3: 50.0%) and to 53.6% (PY: 52.3%) for the full year.

In the 10 years since 2014, gross profit on average climbed by +8.9% per year, with a much more steady development than sales.

**Double system change increased expenses**

Due to the double system conversion, the increase in personnel expenses was slightly higher than the +4.7% in the previous year at +5.5% to EUR 104.81 mln (PY: 99.36). Other operating expenses increased to EUR 22.21 mln (PY: 19.29 / +15%), while other operating income improved to EUR 9.17 mln (PY: 6.75 / +36%).

Operating profit EBITDA before depreciation, amortization, interest and taxes marginally grew to EUR 56.74 mln (PY: 56.64 / +0.2%).

**Depreciation slightly above PY**

Depreciation was slightly above PY, with EUR 3.96 mln (PY: 3.46) for fixed assets, EUR 5.78 mln (PY: 5.83) for depreciation leasing (IFRS16) and EUR 0.52 mln (PY: 0.52) for amortization on purchase price allocation (PPA).

**Operating profit EBIT just below PY**

Operating profit EBIT before interest and taxes at EUR 46.47 mln (PY: 46.83 / -0.8%) came in just below the previous year. M+M Software contributed EUR 30.59 mln (PY: 28.42 / +7.6%), the Digitization segment EUR 15.89 mln (PY: 18.41 / -13.7%). The EBIT margin was 14.3% (PY: 14.5%).

**Ten-year EBIT growth +21% p.a.**

In the 10 years since 2014, EBIT at +21% p.a. expanded significantly disproportionately to gross profit at +8.9% per year.

**Seasonality: Roller coaster in Q3/Q4**

Quarterly seasonality in the first half of 2024 was quite similar to the previous year, with a strong Q1 and a softer Q2. In Q3, before the switch to the new Autodesk billing model, a final resale boost was recorded with very high sales and noticeably higher growth rates in gross profit and EBIT.

In Q4, however, the retarding effects of the system changes caused a dip in gross profit and EBIT, while the sales drop was mainly technical, as it resulted from the elimination of Autodesk resale purchases.

**Quarterly revenue:**

- Q1: EUR 100.87 mln (PY: 103.06 / -2.1%)
- Q2: EUR 75.10 mln (PY: 71.32 / +5.3%)
- Q3: EUR 94.10 mln (PY: 67.84 / +39%)
- Q4: EUR 55.77 mln (PY: 80.09 / -30.4%)

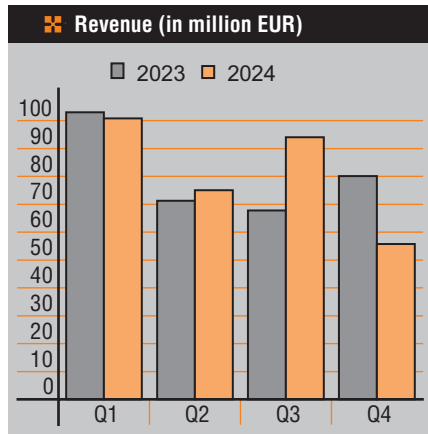

**Quarterly gross profit:**

- Q1: EUR 50.18 mln (PY: 47.09 / +6.6%)
- Q2: EUR 43.36 mln (PY: 40.97 / +5.8%)
- Q3: EUR 41.52 mln (PY: 37.95 / +9.4%)
- Q4: EUR 39.54 mln (PY: 42.53 / -7.0%)

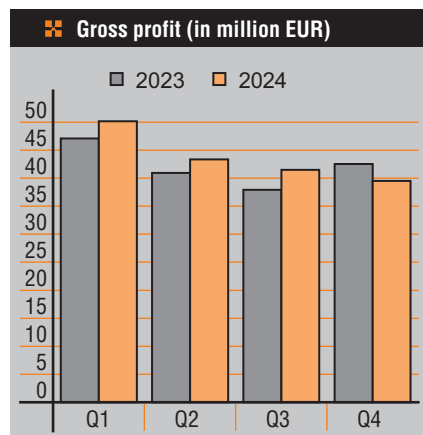

**Quarterly EBIT:**

- Q1: EUR 16.86 mln (PY: 15.81 / +6.6%)
- Q2: EUR 11.12 mln (PY: 10.52 / +5.7%)
- Q3: EUR 10.11 mln (PY: 8.08 / +25%)
- Q4: EUR 8.38 mln (PY: 12.42 / -32.5%)

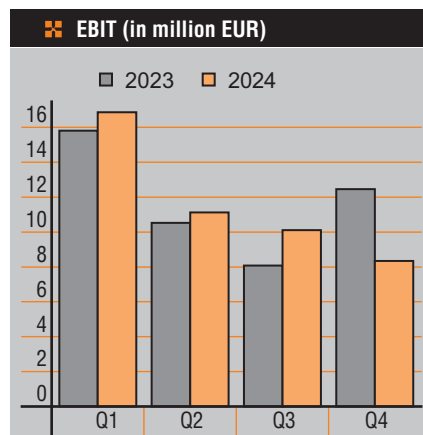

Pretax profit increased to EUR 45.53 mln (PY: 45.22 / +0.7%). Income tax rate fell to 26.57% (PY: 29.4%), tax charge sank to EUR -12.10 mln (PY: -13.30 / -9.0%).

**Record net profit 180 Cents/share**

After tax and minority shares amounting to EUR 2.95 mln (PY: 3.06), net profit reached a new record at EUR 30.49 mln (PY: 28.87 / +5.6%) or 180 Cts/share (PY: 172). In the 10 years since 2014, net profit climbed by +22% p.a.

**Highlight: Record cashflow 369 Cts/share**

The 2024 highlight was operating cashflow achieving a new record EUR 62.32 mln (PY: 50.59 / +23%) or 369 CPS (PY: 302). Since 2014 cashflow increased +25% p.a.

**Dividend proposal 185 Cents (+12%)**

Management will propose to the annual shareholders' meeting on May 8, 2025 to pay 185 Cents (PY: 165) dividend per share. 75 of 185 Cents can be paid out pre-tax from the 'steuerliches Einlagenkonto' (§27 KStG). The maximum total payout is EUR 31.73 mln, the exact amount depends on the then actual number of shares in treasury stock. As in previous years, we plan to optionally offer cash or share dividend.

**Dividend +25% p.a. since 2014**

In the 10 years since 2014 the dividend has increased more than ninefold from 20 to 185 Cents - an expansion by +25% p.a.

**Investing activities**

As in the M+M business model the main future investment is in the area of software development, the expenses for which are mostly not capitalized, there is only relatively small capital expenditure necessary.

In 2024 capital expenditure amounting to EUR 10.93 mln (PY: 7.21) was mainly spent on the renewal of fixed assets (e.g. internal IT projects and new software developments, among others in the area of digital twins) and on subsidiary shareholdings.

**Total assets 13% higher**

Total assets expanded by 13% to EUR 211.89 mln (PY: 187.20).

**Equity 5% higher / ratio 49.5%**

Shareholders' equity as of Dec 31, 2024, grew to EUR 104.91 mln (PY: 99.76 / +5%), equity ratio sank to 49.5% (PY: 53.3%).

**New Autodesk partner model:****Less non value-adding revenue ...**

The change in the partner model from resale to commission executed by Autodesk from Q4/2024 is expressly welcomed by MuM. It reduces revenue by non value-adding parts of cost of materials and in return is improving our profit margins significantly.

**... but significantly more profit margins**

The sales and gross profit graphic on page 22 shows the rough Autodesk resale shares in the cost of materials for 2014-2024.

Without these (top row) shares, a simulated pro forma sales development results under the conditions of the new model.

In 2024 sales would have been an estimated EUR 103 mln lower at around EUR 223 mln with full year new model, meaning that the gross margin would have been around 78% instead of 53.6% and the EBIT margin would have been around 21% instead of 14.3%.

*The M+M headquarters in Wessling near Munich, also used as a solar power plant (-> page 14)*





### Review and Outlook

During the past ten years since 2014, gross profit has gained +8.9% per year, while EBIT grew clearly disproportionately by +21% per year. This sustainable profit increase was achieved by just +6.2% p.a. growth in operating expenses (Opex).

#### Active & decentral cost control ...

This is reached by actively controlling costs at approx. 2/3 of gross profit development, decentralized at the level of around 100 profit centers, into which the M+M business is divided regionally and by sectors.

This development is shown in the graphic on the right, with Opex and EBIT stacked on each other forming the gross profit.

It is easy to see that the model worked well even during short-term dips in gross profit.

#### ... working well even in difficult phases

E.g. in 2017, when Autodesk's transition from software license sale to subscription damped gross profit growth to just +3.7%, but flat expenses led to disproportionate +22% EBIT increase.

Or during the Corona situation, when consistent cost management in the two-year period 2020/21 was able to generate an EBIT jump of +28% from just +8.2% in gross profit.

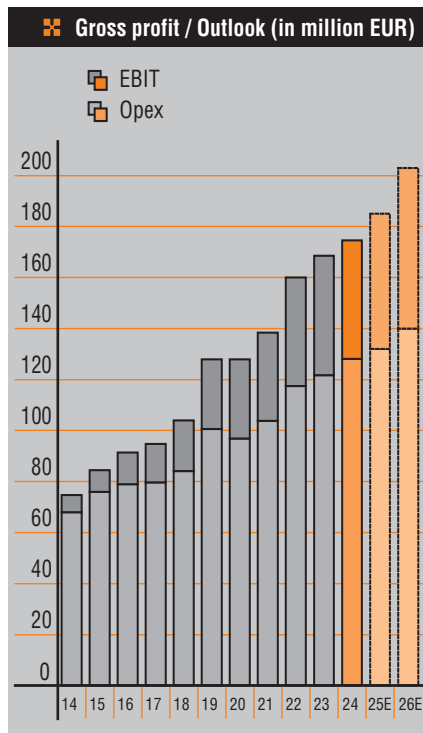

#### Highly scalable business model ...

This shows that M+M has a highly scalable business model and is able to generate disproportionate profit increases through its active and decentral cost control, even and above all in challenging phases.

#### ... with a high dividend payout ratio ...

By accounting for the lion's share of software development as operating cost, M+M can afford a high dividend payout ratio without endangering our future.

#### ... remains our strategy for the future

Also for the future, it is M+M management's clear goal to grow sustainably and profitably by consequent continuation of this strategy.

#### Target: Doubling earnings in 4-5 years

Our mid-term target is to double earnings in 4-5 years, i.e. net profit/share (EPS) >360 Cents by 2028 or 2029.

This perspective is based on organic growth without major acquisitions.

For the next two financial years, the following targets result from this objective:

#### 2025E: EPS +9-19% / Div. 205-215 Cents

In 2025 we expect +5-7% increase in gross profit to EUR 183-187 mln, +9-19% to 196-214 Cents in EPS and EUR 51-55 mln in EBIT. We plan a +20-30 Cents dividend increase to 205-215 Cents for 2025.

#### 2026E: EPS +13-25% / Div. +25-40 Cents

For 2026 we expect a stronger growth of +8-12% in gross profit, +13-25% in EPS as well as in EBIT and are planning +25-40 Cents more in dividends.

#### All estimates subject to error

All forward looking statements and targets mentioned herein are subject to market conditions occurring in line with estimations in the planning models set up by the management. Therefore no guarantee can be undertaken for meeting the estimates.

**Target achievement 2024**

The net profit target '189-206 Cents/share' for 2024 from the annual report 2023 was missed by the achieved 180 Cents.

**Events after the balance sheet date**

There were no material events after the balance sheet date.

**Expression of thanks**

We would like to take the opportunity to thank all employees for their engaged work, which helped M+M to achieve rather decent results in the - due to our double system conversion and the economic environment - very challenging year 2024.

In addition, we would like to express our thanks to our customers, suppliers and shareholders for their continued loyalty to M+M. We will do our very best to keep deserving this loyalty in the future.

Wessling, March 2025  
 Mensch und Maschine Software SE  
 The Managing Directors

*The M+M share price augmented significantly since 2010. In addition, dividends of 875 cents were distributed during this period, so that the total value for the shareholder has grown enormously. The price performance corresponded to that of the TecDAX and DAX Software until 2015, but since then the M+M share has had a big lead and has more or less moved within the framework of an initial dividend yield of 2% since 2016, with deviations down to 1.5% during the 2020/21 bull market and up to nearly 4% in the years since 2022. By the way: Anyone who has invested EUR 1,000 a month in the M+M share since August 1997, i.e. one month after the IPO, had already received 126% of the total investment of EUR 329 thousand in dividends by Dec 31, 2024 and was able to enjoy a total value before taxes of TEUR 2,924, i.e. nearly nine times the stake.*

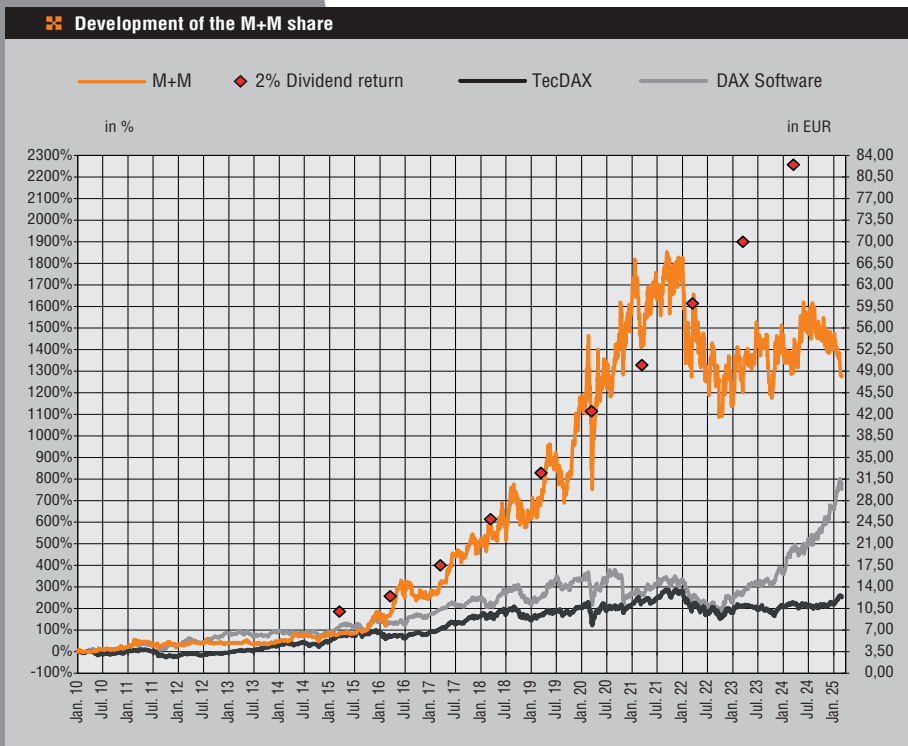

Statement of income						
Amount in KEUR	Note	2024		Δ%	2023	
<b>Revenues</b>	<b>1</b>	<b>325,844</b>	<b>100%</b>	<b>+1.1%</b>	<b>322,306</b>	<b>100%</b>
Cost of materials	2	-151,254	-46.4%	-1.6%	-153,772	-47.7%
<b>Gross profit</b>		<b>174,590</b>	<b>53.6%</b>	<b>+3.6%</b>	<b>168,534</b>	<b>52.3%</b>
Personnel expenses	3	-104,810	-32.2%	+5.5%	-99,360	-30.8%
Other operating expenses	4	-22,212	-6.8%	+15%	-19,288	-6.0%
Other operating income	6	9,170	2.8%	+36%	6,752	2.1%
<b>Operating result EBITDA</b>		<b>56,738</b>	<b>17.4%</b>	<b>+0.2%</b>	<b>56,638</b>	<b>17.6%</b>
Depreciation	5	-3,963	-1.2%	+15%	-3,457	-1.1%
Depreciation finance leasing (IFRS 16)	5	-5,783	-1.8%	-0.9%	-5,833	-1.8%
Amortisation PPA	5	-517	-0.2%	0%	-517	-0.2%
<b>Operating result EBIT</b>		<b>46,475</b>	<b>14.3%</b>	<b>-0.8%</b>	<b>46,831</b>	<b>14.5%</b>
Financial result	7	-942	-0.3%	-41%	-1,608	-0.5%
<b>Result before taxes</b>		<b>45,533</b>	<b>14.0%</b>	<b>+0.7%</b>	<b>45,223</b>	<b>14.0%</b>
Taxes on income	8	-12,098	-3.7%	-9.0%	-13,296	-4.1%
Net result after taxes		33,435	10.3%	+4.7%	31,927	9.9%
<b>thereof attributable to M+M shareholders</b>		<b>30,487</b>	<b>9.4%</b>	<b>+5.6%</b>	<b>28,867</b>	<b>9.0%</b>
thereof attributable to minority shareholders		2,948	0.9%	-3.7%	3,060	0.9%
Net income per share in EUR	9	1,8031		+4.8%	1,7210	
Weighted average shares outstanding in million		16,908		+0.8%	16,773	

\*see notes on pages 48 to 50

Consolidated statement of comprehensive income			
Amounts in KEUR		2024	2023
Net result after taxes		33,435	31,927
<b>thereof attributable to M+M shareholders</b>		<b>30,487</b>	<b>28,867</b>
thereof attributable to minority shareholders		2,948	3,060
Currency conversion difference		196	520
<b>Other comprehensive income that may be reclassified subsequently to profit or loss</b>		<b>196</b>	<b>520</b>
Actuarial gains / losses on pension obligations		68	-98
Deferred taxes thereof		-20	29
<b>Other comprehensive income that will not be reclassified subsequently to profit or loss</b>		<b>48</b>	<b>-69</b>
<b>Total other result</b>		<b>244</b>	<b>451</b>
Total comprehensive income		33,679	32,378
<b>thereof attributable to M+M shareholders</b>		<b>30,731</b>	<b>29,318</b>
thereof attributable to minority shareholders		2,948	3,060



 Balance sheet

Amounts in KEUR	Note*	Dec 31, 2024	△%	Dec 31, 2023
Cash and cash equivalents		42,997	+73%	24,867
Trade accounts receivable	10	35,171	-14%	40,903
Inventories	11	8,436	+52%	5,540
Prepaid expenses and other current assets	12	13,668	+34%	10,235
<b>Total current assets</b>		<b>100,272</b> 47.3%	<b>+23%</b>	<b>81,545</b> 43.6%
Property, plant and equipment		5,416	-2%	5,517
Real estate		17,319	-2%	17,686
Intangible assets		28,247	+28%	22,011
Goodwill	13	47,874	0%	47,874
Other investments		32	-11%	36
Rights to use leasing contracts (IFRS 16)	14	11,418	-1%	11,484
Deferred taxes	8	1,314	+26%	1,046
<b>Total non current assets</b>		<b>111,620</b> 52.7%	<b>+6%</b>	<b>105,654</b> 56.4%
<b>Total assets</b>		<b>211,892</b> 100%	<b>+13%</b>	<b>187,199</b> 100%
Short term debt and current portion of long term debt	15	3,013	+27%	2,375
Current finance lease obligations (IFRS 16)	14	5,162	+5%	4,904
Trade accounts payable		33,414	+17%	28,530
Accrued expenses	16	12,405	-6%	13,183
Deferred revenues		6,184	+23%	5,028
Income tax payable		4,938	-29%	6,928
Other current liabilities	17	7,147	-20%	8,925
<b>Total current liabilities</b>		<b>72,263</b> 34.1%	<b>+3%</b>	<b>69,873</b> 37.3%
Long term debt, less current portion	18	4,558	-12%	5,197
Long term finance lease obligations (IFRS 16)	14	6,399	-5%	6,722
Non current trade accounts payable	19	16,293		0
Deferred taxes	8	7,299	+35%	5,422
Pension accruals	20	85	-43%	148
Other accruals	16	80	0%	80
<b>Total non current liabilities</b>		<b>34,714</b> 16.4%	<b>+98%</b>	<b>17,569</b> 9.4%
Share capital	21	17,149	0%	17,149
Capital reserve and other reserves	22	49,299	+5%	47,160
Treasury stock	23	-11,726	-4%	-12,244
Retained earnings / accumulated deficit		42,272	+7%	39,556
Other comprehensive income / loss		-430	-25%	-577
Equity attributable to non-controlling (minority) interest		6,455	-7%	6,906
Currency conversion		1,896	+5%	1,807
<b>Total shareholders' equity</b>		<b>104,915</b> 49.5%	<b>+5%</b>	<b>99,757</b> 53.3%
<b>Total liabilities and shareholders' equity</b>		<b>211,892</b> 100%	<b>+13%</b>	<b>187,199</b> 100%

\* see notes on pages 49, 51 to 57

## Statement of cash flows Development of shareholders' equity

 Statement of cash flows		
Amounts in KEUR	2024	2023
<b>Net profit</b>	<b>33,435</b>	<b>31,927</b>
Interest result	-144	351
Depreciation and amortization	10,263	9,808
Other non cash income / expenses	2,470	2,087
Increase/decrease in provisions and accruals	-847	19
Gains/losses from the disposal of fixed assets	-36	-122
Change in net working capital	17,177	6,519
<b>Net cash provided by (used in) operating activities</b>	<b>62,318</b>	<b>50,589</b>
Purchase of subsidiaries, net of cash	-749	-513
Purchase of real estate	-20	-526
Purchase of other fixed assets	-10,300	-6,428
Sale of other fixed assets	136	255
<b>Net cash provided by (used in) investing activities</b>	<b>-10,933</b>	<b>-7,212</b>
Proceeds from issuance of share capital	2,606	1,636
Interest proceeds/payments	6	-484
Purchase/disposal of treasury stock	518	7,029
Dividend payment to M+M shareholders	-27,771	-23,335
Dividend payment to minority shareholders	-3,117	-3,175
Proceeds from short or long term borrowings	-1	-18,818
Change in finance lease obligations IFRS 16	-5,781	-5,827
<b>Net cash provided by (used in) financing activities</b>	<b>-33,540</b>	<b>-42,974</b>
Net effect of currency translation in cash and cash equivalents	285	97
<b>Net increase / decrease in cash and cash equivalents</b>	<b>18,130</b>	<b>500</b>
<b>Cash and cash equivalents at beginning of period</b>	<b>24,867</b>	<b>24,367</b>
<b>Cash and cash equivalents at end of period</b>	<b>42,997</b>	<b>24,867</b>

see notes on page 58

 Development of shareholders' equity									
Amounts in KEUR	Subscribed Capital	Capital Reserve	Profit/ Loss	Other comprehensive income/loss	Treasury stock	Currency conversion	attributable to M+M SE shareholders	Minority interest	Total equity
<b>As of Dec 31, 2022</b>	<b>17,149</b>	<b>46,588</b>	<b>34,024</b>	<b>-509</b>	<b>-19,853</b>	<b>1,289</b>	<b>78,686</b>	<b>7,063</b>	<b>85,751</b>
Treasury stock		33			868		901		901
Dividend		1,603	-23,335		6,741		-14,991	-3,175	-18,166
Net result			28,867				28,867	3,060	31,927
Minority interest change		-1,064					-1,064	-42	-1,106
Other comprehensive income from pension assessment				-68			-68		-68
Currency conversion						518	518		518
<b>As of Dec 31, 2023</b>	<b>17,149</b>	<b>47,160</b>	<b>39,556</b>	<b>-577</b>	<b>-12,244</b>	<b>1,807</b>	<b>92,849</b>	<b>6,906</b>	<b>99,757</b>
Treasury stock		148			-6,318		-6,170		-6,170
Dividend		2,457	-27,771		6,836		-18,478	-3,117	-21,595
Net result			30,487				30,487	2,948	33,435
Minority interest change		-466					-466	-282	-748
Other comprehensive income from pension assessment				47			47		47
Currency conversion				100		89	189		189
<b>As of Dec 31, 2024</b>	<b>17,149</b>	<b>49,299</b>	<b>42,272</b>	<b>-430</b>	<b>-11,726</b>	<b>1,896</b>	<b>98,458</b>	<b>6,455</b>	<b>104,915</b>

# Notes

## Segment reporting

According to IFRS 8, reportable operating segments are identified based on the 'management approach'. This approach stipulates external segment reporting based on the Group's internal organizational and management structure and on internal financial reporting to the chief operating decision maker.

The measurement principles for the segment reporting structure are based on the IFRS principles adopted in the consolidated financial statements. M+M evaluates the segments' performance based on their profit/loss from operations (EBIT), among other factors. Revenue generated and goods and services exchanged between segments are calculated on the basis of market prices.

Segment assets and liabilities include all assets and liabilities that are attributable to operations and whose positive or negative results determine profit/loss from operations. Segment assets include, in particular, intangible assets; property, plant and equipment; trade and other receivables; and inventories. Segment liabilities include, in particular, trade and other payables, and significant provisions.

Segment investments include additions to intangible assets and property, plant and equipment. Deferred tax assets and liabilities are not included in the segment assets and segment liabilities.

The M+M business model is divided into the two segments M+M Software and M+M Digitization (formerly VAR Business). The Software segment includes the sales and marketing of self-developed CAD/CAM/CAE/BIM software.

The Digitization segment includes the development of customer-specific software solutions, the resale or agency against commission of third-party software and hardware as well as related services.

The sum of the operating results (EBIT), determined at the level of the segments, agrees with the operating result in the statement of income. The financial result and the taxes on income are not controlled at segment level. Therefore the representation of reconciliation to the net result after taxes is not shown.

According to the regulations of IFRS 8 the revenues are also differentiated in Germany, the domicile of Mensch und Maschine Software SE, and business in foreign countries.





Segmentation										
Amounts in KEUR	M+M Software					M+M Digitization*				
	2024		△%	2023		2024		△%	2023	
<b>Revenue</b>	<b>109,316</b>	<b>100%</b>	<b>+4,5%</b>	<b>104,625</b>	<b>100%</b>	<b>216,527</b>	<b>100%</b>	<b>-0,5%</b>	<b>217,682</b>	<b>100%</b>
share in percent	33.5%			32.5%		66.5%			67.5%	
Cost of materials	-10,291	-9.4%	+6.3%	-9,679	-9.3%	-140,963	-65.1%	-2.2%	-144,093	-66.2%
<b>Gross profit</b>	<b>99,025</b>	<b>90.6%</b>	<b>+4.3%</b>	<b>94,946</b>	<b>90.7%</b>	<b>75,565</b>	<b>34.9%</b>	<b>+2.7%</b>	<b>73,588</b>	<b>33.8%</b>
share in percent	56.7%			56,3%		43.3%			43,7%	
Personnel expenses	-54,870	-50.2%	+5.5%	-51,990	-49.7%	-49,940	-23.1%	+5,4%	-47,370	-21.8%
Other operating expenses	-12,531	-11.5%	+7.6%	-11,646	-11.1%	-9,681	-4.5%	+27%	-7,642	-3.5%
Other operating income	3,605	3.3%	+103%	1,780	1.7%	5,565	2.6%	+12%	4,972	2.3%
Depreciation	-1,925	-1.8%	-2.3%	-1,971	-1.9%	-2,038	-0.9%	+37%	-1,486	-0.7%
Depreciation Leasing (IFRS 16)	-2,199	-2.0%	+0.6%	-2,186	-2.1%	-3,584	-1.7%	-1.7%	-3,647	-1.7%
Amortisation purchase price allocation PPA	-517	-0.5%	0%	-517	-0.5%	0	0.0%		0	0.0%
<b>Operating result EBIT</b>	<b>30,588</b>	<b>28.0%</b>	<b>+7.6%</b>	<b>28,416</b>	<b>27.2%</b>	<b>15,887</b>	<b>7.3%</b>	<b>-13,7%</b>	<b>18,415</b>	<b>8.5%</b>
share in percent	65.8%			60.7%		34.2%			39.3%	
Segment assets	80,335			80,971		130,222			105,181	
Fixed assets	49,293			48,101		61,012			56,507	
Investments	3,932			2,149		6,387			4,804	
Liabilities	26,773			29,599		77,735			56,127	

\*former segment name: VAR Business

Geographical segmentation				
Amounts in KEUR	2024		2023	
	Germany	International	Germany	International
<b>External revenue</b>	<b>138,460</b>	<b>187,389</b>	<b>133,493</b>	<b>188,813</b>
share in percent	42.5%	57.5%	41.4%	58.6%
Fixed assets	79,601	30,704	73,165	31,443
Investments	9,704	615	6,258	695

## General remarks

### Basis of the group financial statements

The consolidated financial statements of Mensch und Maschine Software SE, Wessling, Germany have been drawn up in compliance with International Financial Reporting Standards (IFRS) according to the specifications as defined in the currently valid guidelines of the International Accounting Standards Board (IASB). All IFRS and International Accounting Standards (IAS) as well as the interpretations of the International Financial Reporting Interpretations Committee (IFRIC) or the former Standing Interpretations Committee (SIC) which have been in effect at the closing date, and accepted by the EU, have been considered.

In addition to that, the regulations of Article 315e of the German Commercial Code and §160 of the German Stock Corporation Act have been considered.

M+M SE is a global enterprise based in Germany, headquartered at Argelsrieder Feld 5, 82234 Wessling and registered in the Commercial Register of the Munich Local Court under the number HRB 165230. Its business activities are focused on technical software.

The Managing Directors of M+M SE approved the consolidated financial statements on February 24, 2025 for submission to the company's Administrative Board.

The Administrative Board approved the consolidated financial statements at its meeting on March 10, 2025 and approved for publication on March 13, 2025.

The consolidated financial statements have been prepared in Euros. Unless otherwise specified, all amounts are stated in thousand Euros (KEUR).

These consolidated financial statements were prepared for the 2024 fiscal year (January 1 to December 31).

### Changes in accounting policies

The IASB has approved a number of changes to the existing IFRS and adopted several new IFRS, which became effective as of January 1, 2024. M+M is applying the following IFRSs in the reporting period for the first time:

IAS 1	Classification of Liabilities as Current or Non-current
IAS 1	Non-current Liabilities with Covenants
IFRS 16	Lease Liability in a Sale and Leaseback
IAS 7 / IFRS 7	Supplier Finance Arrangements

The application of these changes had no material impact on the M+M consolidated financial statements.

#### **New accounting policies**

The IASB and IFRIC have adopted further standards and interpretations, which were endorsed by the European Union but not yet effective in the 2024 financial year:

IAS 21 The Effects of Changes in Foreign Exchange Rates: Lack of Exchangeability

The following standards and interpretations have not yet been endorsed by the European Union:

IFRS 7 / IFRS 9

Amendments to the Classification and Measurement of Financial Instruments

IFRS 18 Presentation and Disclosure in Financial Statements

IFRS 19 Subsidiaries without Public Accountability: Disclosures

These Standards and Interpretations have to be applied for annual periods beginning after January 1, 2025. These regulations have not been early adopted by the M+M group.

The application of these standards is not expected to have a material impact on the Group's financial statement 2025.

## Valuation methods and accounting policies applied

### Consolidated companies and closing date

In addition to the parent company, the consolidated financial statement comprises all directly and indirectly owned domestic and international subsidiaries, at which M+M SE holds directly or indirectly the majority of the voting rights or the control of the economic power, which are included in accordance with the principles of full consolidation. They are deconsolidated when the parent ceases to have control.

In addition to the parent company, the following companies were fully consolidated in the group financial statements of December 31, 2024.

The balance sheet closing date for the subsidiaries included in the group consolidated financial statement is December 31.

In fiscal year 2024, the percentage ownership of the subsidiary Mensch und Maschine At Work GmbH, Bissendorf, Germany was increased from 85.03% to 100 %. In accordance with IFRS 3 (Business combinations after January 1, 2010) the expected purchase price liability was recorded in equity by KEUR 466.

### M+M group consolidated companies

Mensch und Maschine Management AG, Wessling, Germany	100%	SOFISTIK AG, Oberschleissheim, Germany	51,4%
Mensch und Maschine Germany GmbH, Wessling, Germany	100%	and shareholdings:	
Mensch und Maschine Infrastruktur GmbH, Stuttgart, Germany	70%	BiMOTION GmbH, Nürnberg, Germany	51%
Mensch und Maschine At Work GmbH, Bissendorf, Germany	100%	SOFISTIK North America Corp., New York, USA	100%
customX GmbH, Limburg, Germany	58.1%	SOFISTIK ME LTD, Tel Aviv, Israel	51%
Mensch und Maschine Scholle GmbH, Velbert, Germany	87.5%	SOFIN Consulting Ltd., Espo, Finland	51%
Mensch und Maschine acadGraph GmbH, München, Germany	93.4%	SOFISTIK India Privat Limited, Delhi, India	100%
Mensch und Maschine Schweiz AG, Winkel (Zürich), Switzerland	100%	OPEN MIND Technologies AG, Wessling, Germany	100%
Mensch und Maschine Austria GmbH, Großwilfersdorf, Austria	100%	and shareholdings:	
Man and Machine France S.a.r.l., Paris, France	100%	OPEN MIND Technologies USA Inc., Needham, MA, USA	100%
Man and Machine Software s.r.l., Vimercate (Mailand), Italy	100%	OPEN MIND Technologies Asia Pacific Ltd., Singapore	100%
Man and Machine Software Sp. z o.o., Lodz, Poland	100%	OPEN MIND Technologies S.r.l., Rho, Italy	100%
Man and Machine Ltd., Thame, UK	100%	OPEN MIND CAD-CAM Technologies S.r.l., Rho, Italy	100%
Man and Machine Romania SRL, Bukarest, Romania	100%	OPEN MIND Technologies France S.a.r.l., Limas, France	100%
Mensch und Maschine Hungary Kft, Sopron, Hungary	50.1%	OPEN MIND Technologies Japan Inc., Tokyo, Japan	100%
Mensch und Maschine Medienzentrum AG, Wessling, Germany	99.7%	OPEN MIND Technologies Portugal, Marinha Grande, Portugal	100%
Mensch und Maschine Mechatronik GmbH, Donzdorf, Germany	100%	OPEN MIND Technologies UK Limited, Bicester, UK	100%
DATAflor Software AG, Göttingen, Germany	67.2%	OPEN MIND Technologies China Co.Ltd, Shanghai, China	100%
		OPEN MIND Technologies Taiwan Inc., New Taipei City, Taiwan	100%
		OPEN MIND Technologies Schweiz GmbH, Wängi, Switzerland	100%
		OPEN MIND CAD-CAM Technologies India Private Ltd, Bangalore, India	100%
		OPEN MIND Technologies Spain S.L., Valencia, Spain	100%
		OPEN MIND Tecnologia Brasil LTDA, Sao Paulo, Brazil	100%
		OPEN MIND Technologies Benelux BV, Hertogenbosch, Netherlands	100%
		OPEN MIND Technologies Scandinavia AB, Göteborg, Sweden	100%
		Hummingbird Systems GmbH, Nürnberg, Germany	51%



### Other remarks

The financial statements of all group companies were drawn up on the basis of common accounting principles. As far as there is an obligation to examine, they are audited by independent auditors and endorsed by an unqualified audit opinion.

The following domestic subsidiaries made use in 2024 of certain exemptions granted under Sections 264, paragraph 3 of the German Commercial Code regarding the management report and release from the publication of financial statements:

- Mensch und Maschine Management AG, Wessling, Germany
- Mensch und Maschine Deutschland GmbH, Wessling, Germany
- OPEN MIND Technologies AG, Wessling, Deutschland

### Principles of consolidation

The consolidated financial statements include subsidiaries. Subsidiaries are companies over which M+M is currently able to exercise power by virtue of existing rights. Power means the ability to direct the activities that significantly influence a company's profitability. Control is therefore only deemed to exist if M+M is exposed, or has rights, to variable returns from its involvement with a company and has the ability to use its power over that company to affect the amount of that company's returns. The ability to control another company generally derives from M+M direct or indirect ownership of a majority of the voting rights.

Inclusion of an entity's accounts in the consolidated financial statements begins when the Group is able to exercise control over the entity and ceases when it is no longer able to do so.

Business combinations after January 1, 2010 are accounted for using the acquisition method. The cost of an acquisition is measured as the aggregate of the consideration transferred, measured at acquisition date fair value and the amount of any non-controlling interest in the acquiree. For each business combination, the acquirer measures the non-controlling interest in the acquiree either at fair value or at the proportionate share of the acquiree's identifiable net assets.

Acquisition costs incurred are expensed and included in administrative expenses.

When the Group acquires a business, it assesses the financial assets and liabilities assumed for appropriate classification and designation in accordance with the contractual terms, economic circumstances and pertinent conditions as at the acquisition date. This includes the separation of embedded derivatives in host contracts by the acquiree.

If the business combination is achieved in stages, the acquisition date fair value of the acquirer's previously held equity interest in the acquiree is remeasured to fair value at the acquisition date through profit or loss. Any contingent consideration to be transferred by the acquirer will be recognized at fair value at the acquisition date.

The purchase of shares (participation rate increase) after the initial consolidation is accounted for as an equity transaction.

Subsequent changes to the fair value of the contingent consideration which is deemed to be an asset or liability will be recognized in accordance with IAS 39 either in profit or loss or as a change to other comprehensive income. If the contingent consideration is classified as equity, it should not be remeasured until it is finally settled within equity.

Goodwill is initially measured at cost being the excess of the aggregate of the consideration transferred and the amount recognized for non-controlling interest over the net identifiable assets acquired and liabilities assumed. If this consideration is lower than the fair value of the net assets of the subsidiary acquired, the difference is recognized in profit or loss.

After initial recognition, goodwill is measured at cost less any accumulated impairment losses. For the purpose of impairment testing, goodwill acquired in a business combination is, from the acquisition date, allocated to each of the Group's cash-generating units that are expected to benefit from the combination, irrespective of whether other assets or liabilities of the acquiree are assigned to those units.

Where goodwill forms part of a cash-generating unit and part of the operation within that unit is disposed of, the goodwill associated with the operation disposed of is included in the carrying amount of the operation when determining the gain or loss on disposal of the operation.

Goodwill disposed of in this circumstance is measured based on the relative values of the operation disposed of and the portion of the cash-generating unit retained.

For business combinations prior to January 1, 2010 in comparison to the above-mentioned requirements, the following differences applied:

Business combinations were accounted for using the purchase method. Transaction costs directly attributable to the acquisition formed part of the acquisition costs. The non-controlling interest (formerly known as minority interest) was measured at the proportionate share of the acquiree's identifiable net assets.

Business combinations achieved in stages were accounted for as separate steps. Any additional acquired share of interest did not affect previously recognized goodwill.

When the Group acquired a business, embedded derivatives separated from the host contract by the acquiree were not reassessed on acquisition unless the business combination resulted in a change in the terms of the contract that significantly modified the cash flows that otherwise would have been required under the contract.



Contingent consideration was recognized if, and only if, the Group had a present obligation, the economic outflow was more likely than not and a reliable estimate was determinable.

Subsequent adjustments to the contingent consideration were recognized as part of goodwill.

The differences arising from the consolidation of capital, to the extent that they are assets, are indicated as goodwill under non-current assets.

Non-controlling interests are valued at closing time with their share in shareholders' equity respective earnings of the year of the particular subsidiary.

Receivables, reserves, liabilities, accruals and deferrals resulting from intra-group transactions are mutually offset. Differences from the consolidation of debt are treated with effect on earnings.

Contingent liabilities were consolidated to the required extent. Interim profits and losses resulting from intra-group supply and service trading were likewise eliminated as were investment returns from companies included in the consolidation. Intra-group sales revenues as well as other intra-group earnings were offset by the appropriate expenditures.

With regard to the consolidation measures affecting results, tax deferrals pursuant to IAS 12 were carried out to the extent that the deviation in tax expenditure would conceivably be balanced in future fiscal years.

#### **Management judgements in the application of accounting policies**

The presentation of the results of operations, financial position or cash flows in the consolidated financial statements is dependent upon and sensitive to the accounting policies, assumptions and estimates. The actual amounts may differ from those estimates.

The following critical accounting estimates and related assumptions and uncertainties inherent in accounting policies applied are essential to understand the underlying financial reporting risks and the effects that these accounting estimates, assumptions and uncertainties have on the consolidated financial statements.

Measurement of property, plant and equipment, and intangible assets involves the use of estimates for determining the fair value at the acquisition date, in particular in the case of such assets acquired in a business combination. Furthermore, the expected useful lives of these assets must be estimated. The determination of the fair values of assets and liabilities, as well as of the useful lives of the assets is based on management's judgement.

The determination of impairments of property, plant and equipment as well as intangible assets involves the use of estimates that include, but are not limited to, the cause, timing and amount of the impairment.

Impairment is based on a large number of factors, such as changes in current competitive conditions, expectations of growth, increased cost of capital, changes in the future availability of financing, technological obsolescence, discontinuance of services, current replacement costs, prices paid in comparable transactions and other changes in circumstances that indicate an impairment exists. The recoverable amount and the fair values are typically determined using a discounted cash flow method which incorporates reasonable market participant assumptions.

The identification of impairment indicators, as well as the estimation of future cash flows and the determination of fair values for assets require management to make significant judgements concerning the identification and validation of impairment indicators, expected cash flows, applicable discount rates, useful lives and residual values.

If the demand for these products and services does not materialize as expected, this would result in less revenue, less cash flow and potential impairment to write down these investments to their fair values, which could adversely affect future operating results.

The determination of the recoverable amount of a cash-generating unit involves the use of estimates by management. To determine the fair value less costs to sell include discounted cash flow-based methods.

Key assumptions on which management has based its determination of fair value less costs to sell include earning development, capital expenditure and market share. These estimates, including the methodologies used, can have a material impact on the fair value and ultimately the amount of any goodwill impairment.

Management maintains an allowance for doubtful accounts to account for estimated losses resulting from the inability of customers to make required payments. When evaluating the adequacy of an allowance for doubtful accounts, management bases its estimates on the aging of accounts receivable balances and historical write-off experience, customer credit worthiness and changes in customer payment terms.

If the financial condition of customers were to deteriorate, actual write offs might be higher than expected.

Income taxes must be estimated for each of the jurisdictions in which the Group operates, involving a specific calculation of the expected actual income tax exposure for each tax object and an assessment of temporary differences resulting from the different treatment of certain items for IFRS consolidated financial and tax reporting purposes. Any temporary differences will generally result in the recognition of deferred tax assets and liabilities in the consolidated financial statements. Management judgement is required for the calculation of actual and deferred taxes.





Deferred tax assets are recognized to the extent that their utilization is probable. The utilization of deferred tax assets will depend on whether it is possible to generate sufficient taxable income in the respective tax type and jurisdiction, taking into account any legal restrictions on the length of the loss carry-forward period. Various factors are used to assess the probability of the future utilization of deferred tax assets, including past operating results, operational plans, loss carry forward periods, and tax planning strategies.

If actual results differ from these estimates or if these estimates must be adjusted in future periods, the financial position, results of operations and cash flows may be negatively affected. In the event that the assessment of future utilization of deferred tax assets changes, the recognized deferred tax assets must be reduced and this reduction be recognized in profit or loss. The only tax loss carry forwards capitalized by M+M are those which can presumably be used within the following five years.

Pension obligations for benefits are generally satisfied by plans which are classified and accounted for as defined benefit plans. Pension benefit costs are determined in accordance with actuarial valuation, which rely on assumptions including discount rates, life expectancies and expected return on plan assets. In the event that further changes in assumptions are required with respect to discount rates and expected returns on invested assets, the future amounts of the pension benefit costs may be affected materially.

The Management exercises considerable judgment in measuring and recognizing provisions and the exposure to contingent liabilities related to litigation or outstanding claims subject to negotiated settlement, mediation, arbitration or government regulation, as well as other contingent liabilities. Judgment is necessary in assessing the likelihood that a claim will succeed, or a liability will arise, and to quantify the possible range of the final settlement.

Provisions are recorded for liabilities when losses are expected from pending contracts, a loss is considered probable and can be reasonably estimated. Because of the inherent uncertainties in this evaluation process, actual losses may be different from the originally estimated provision.

In addition, significant estimates are involved in the determination of provisions related to taxes and litigation risks. These estimates are subject to change as new information becomes available, primarily with the support of internal specialists, if available, or with the support of outside consultants, such as actuaries or legal counsel. Revisions to the estimates of these losses from executory contracts may significantly affect future operating results.

**Currency conversion**

The annual financial statements of the group's international subsidiaries were converted into Euro in accordance with the principle of functional currency in compliance with IAS 21. This refers to the respective national currency for all companies since these international companies are financially, economically and organizationally independent with respect to their operations. Accordingly, equity was converted at the historical exchange rate, the other balance sheet items were converted at the exchange rate on closing date, and income

and expenditures as well as year end results were converted using a mean exchange rate for the year. In compliance with IAS 21, differences arising from currency conversion of both capital consolidation and transfer of the annual earnings to the balance sheet at the mean annual exchange rate were treated as having no effect on earnings and are included within equity. Newly acquired Goodwill is translated as an asset of the economically autonomous foreign entity at the exchange rate in effect on the balance sheet date.

	Average		Year end	
	2024	2023	Dec 31, 2024	Dec 31, 2023
1 Swiss Franc	1.0498	1.0291	1.0625	1.0799
1 British pound	1.1812	1.1496	1.2060	1.1507
1 Polish Zloty	0.2322	0.2202	0.2339	0.2304
1 Swedish Krona	0.0875	0.0872	0.0873	0.0901
1 Romania Ron	0.2010	0.2022	0.2010	0.2010
1 US Dollar	0.9242	0.9246	0.9626	0.9050
1 Singapore Dollar	0.6917	0.6885	0.7060	0.6854
100 Japanese Yen	0.6104	0.6582	0.6133	0.6397
1 Taiwan Dollar	0.0295	0.0294	0.0295	0.0294
1 Renminbi Chinese Yuan	0.1284	0.1306	0.1319	0.1274
1 India Rupie	0.0110	0.0112	0.0112	0.0109
1 Brazil Real	0.1716	0.1851	0.1556	0.1865
1 Hungarian Forint	0.0025	0.0026	0.0024	0.0026
1 Israeli Schekel	0.2497	0.2508	0.2640	0.2500

### Structure of statement of income and balance sheet

In keeping with the international practice of consolidated financial statements, the report begins with the statement of income (profit and loss), itemized according to the nature of expense method.

In accordance with IAS 1, the balance sheet is apportioned into current and non-current assets and into current and non-current liabilities. Assets and liabilities are regarded as current if they mature within one year.

### Accounting and valuation methods

#### Cash and cash equivalent

M+M shows credit balances at banks under cash and cash equivalents. Foreign currency credit balances are converted by exchange rate at closing date.

#### Property, plant and equipment

Property, plant and equipment is reported at cost of acquisition less regular depreciation. These assets are depreciated over the useful economic life of 3 to 50 years.

#### Business combinations

Business combinations are accounted for using the purchase method. Goodwill on acquisition is initially measured at cost being the excess of the cost of the business combination over the acquirer's interest in the net fair value of the identifiable assets, liabilities and contingent liabilities. Following initial recognition, goodwill is measured at cost less any accumulated impairment losses.

According to IFRS 3 (business combinations) goodwill is not amortized, instead it is subjected to an impairment test, at least once every year.

In the context of the impairment test, the recoverable amount of the cash generating units is determined by the current value less sales costs or the value in use. The individual subsidiaries of M+M were defined as cash generating units. The current value reflects the best estimation of the amount, for which an independent third party would acquire the cash generating units as of balance-sheet date. Sale costs are taken off. The value in use is determined on the basis of DCF methods. To calculate this, cash flow projections are based on financial budgets approved by the Administrative Board covering a five-year period. This planning is based on experiences from the past as well as on expectations over the future market development.

The discount rate is determined on the basis of market data and considers credit and market risks. For the cash generating units the after-tax basis discount rate amounts between 7.49% and 11.73%.

If this results in the carrying amount of a cash-generating unit to which goodwill was allocated exceeding the recoverable amount, the allocated goodwill is initially written down by the difference.

Impairment losses which must be recognized in addition to this are taken into account by reducing the carrying amount of the other assets of the cash-generating unit on a prorated basis. If the reason for an impairment loss recognized in prior years has ceased to exist, a write-back is performed, whereby the increased carrying amount resulting from the write-back may not exceed the amortized cost. Impairment losses on goodwill are not reversed.

#### **Other intangible assets**

Intangible assets are reported at cost of acquisition less regular depreciation. These assets are depreciated over the useful economic life of 3 to 15 years and are included in the depreciation.

Intangible assets, acquired in the context of a business combination, are capitalized at fair value as at the date of acquisition. Following initial recognition, the cost model is applied to the class of intangible assets. The useful lives of these intangible assets are assessed to be either finite or indefinite. Where amortisation is charged on assets with finite lives, the useful economic life is up to 15 years. The amortization period for an intangible asset with a finite useful life is reviewed regularly. The expense for the amortization is taken to the income statement through the amortizations.

Intangible assets with an indefinite useful life are tested for impairment once a year at the cash-generating unit level. Intangible assets created within the business are not capitalized and expenditure is charged against profits in the year in which the expenditure is incurred. Development expenditure on an individual project is capitalized if their future recoverability can reasonably be regarded as assured.

Research costs are expensed as incurred

#### **Financial instruments**

A financial instrument is a contract that gives rise to both a financial asset of one entity and a financial liability or equity instrument of another entity.

#### **Financial assets**

Since January 1, 2018, the Group classifies its financial assets into the following evaluation categories:

- those subsequently measured at fair value (either directly in equity or through profit or loss), and
- those measured at amortized cost.





The classification is dependent on the company's business model for managing financial assets and on the contractual cash flows. In the case of assets measured at fair value, gains and losses are recognised either in profit or loss or directly in equity. For investments in equity instruments that are not held for trading, this depends on whether the Group has irrevocably decided at the time of initial recognition to measure the equity instruments at fair value through equity.

A normal market purchase or sale of financial assets is recognised on the trade date, i.e. the date on which the Group undertakes to buy or sell the asset. Financial assets are derecognised when the rights to receive cash flows from the financial assets have expired or have been transferred and the Group has transferred substantially all risks and rewards of ownership. On initial recognition, the Group measures a financial asset at fair value plus, in the case of a subsequent financial asset not measured at fair value through profit or loss, the transaction costs directly attributable to the acquisition of that asset. Transaction costs of financial assets at fair value through profit or loss are recognised as an expense in profit or loss.

Subsequent measurement depends on the Group's business model for managing the asset and the cash flow characteristics of the asset:

- About amortized costs:  
Assets that are held to collect the contractual cash flows, and for which these cash flows represent exclusively interest and principal payments, are measured at amortized cost. Interest income from these financial assets is reported under financial income using the effective interest method. Gains or losses from derecognition are recorded directly in the income statement.
- Financial assets assessed at fair value through profit or loss:  
Assets that are held to collect the contractual cash flows and sell the financial assets, and for which the cash flows represent exclusively interest and principal payments, are measured at fair value through equity. Changes in the carrying amount are recognised in other comprehensive income, except for impairment gains or losses, interest income and foreign exchange gains or losses that are recognised in profit or loss. When the

financial asset is derecognised, the cumulative gain or loss previously recognised in other comprehensive income is reclassified from equity to profit or loss and recognised in other operating income/ expense. Interest income from these financial assets is reported under financial income using the effective interest method.

- Financial assets assessed at fair value through profit or loss:  
Assets that do not meet the other criteria are classified as at fair value through profit or loss and gains or losses are recognised in other operating income/expense in the period in which they arise.

Since January 1, 2018, the Group assesses on a forward-looking basis the expected credit losses associated with its assets measured at amortized cost or at fair value through profit or loss. The impairment method depends on whether there is a significant increase in credit risk.

In the case of trade receivables, the Group applies the simplified approach permitted by IFRS 9, according to which expected credit losses over the term are to be recognised from the initial recognition of the receivables.

### Leases

M+M assesses at the beginning of the contract whether a contract constitutes or contains a lease. This is the case if the contract entitles to control the use of an identified asset against payment of a fee for a certain period of time.

Since January 1, 2019, the group as a lessee recognizes in general for all leases within the statement of financial position an asset for the right of use of the leased assets and a liability for the lease payment commitments at present value.

These are primarily rentals of property and buildings, technical equipment and machinery, other plants and operating and office equipment. The right of use assets reported under property, plant and equipment are recognized at cost less accumulated depreciation and impairment losses. Payments for non-lease components are not included in the determination of the lease liability. The lease liabilities reported under financial liabilities reflect the present value of the outstanding lease payments at the time the asset is made available for use. Lease payments are discounted at the interest rate implicit in the lease if it can be readily determined. Otherwise, they are discounted at the lessee's incremental borrowing rate.

The derivation of the interest rate is based on the assumption that an adequate amount of funds will be raised over an adequate period of time in the amount of an asset comparable to the right of use asset, taking into account the economic environment and comparable collateral.

The lease liabilities include the following lease payments:

- Fixed payments, less lease incentives to be paid by the lessor;
- variable lease payments that are based on an index or an interest rate;
- expected amounts to be payable by the lessee under residual value guarantees;
- the exercise price of a purchase option, if the exercise is reasonably certain and
- payment of penalties for the termination of the lease, if the lease term reflects the lessee exercising an option to terminate the lease.

Right-of-use assets are measured at cost, which are comprised as follows:

- Lease liability,
- lease payments made at or before the commencement date less any lease incentives received,
- initial direct costs, and
- dismantling obligations.



Subsequent measurement is performed at amortized cost. Right-of-use assets are depreciated on a straight-line basis over the lease term, unless the useful life of the underlying asset is shorter. If the lease agreement contains reasonably certain purchase options, the right of use is depreciated over the economic life of the underlying asset.

In subsequent measurement, the lease liability is compounded, and the corresponding interest expense is recognized in the financial result. The lease payments made reduce the carrying amount of the lease liability.

In accordance with the recognition exemptions, low-value leases of and short-term leases (less than twelve months) are recognized in the statement of income. Only leased assets with a value of up to €5,000 are classified as low-value leased assets. Furthermore, the new regulations are not applied to leases of intangible assets. For contracts comprising a non-lease component as well as a lease component, each lease component must be accounted for separately from non-lease component as a lease. The lessee must allocate the contractually agreed-upon payment to the separate lease components based on the relative standalone selling price of the lease component and the aggregated standalone selling price of the non-lease components.

The term of the lease is determined based on the non-cancellable lease term. Especially real estate leases contain extension and termination options. Such contractual conditions offer the greatest possible operational flexibility to the Group. In determining the lease term, all facts and circumstances are considered that provide an economic incentive to exercise renewal options or not to exercise termination options. Lease term modifications from the exercise or non-exercise of such options are only considered in the lease term if they are reasonably certain and are based on an event that is within the control of the lessee.

#### **Financial liabilities**

All financial liabilities are initially measured at fair value, in the case of loans and liabilities less directly attributable transaction costs. After initial recognition, financial liabilities measured at amortized cost are measured at amortized cost using the effective interest method.

In the case of financial liabilities, the Group has not yet made use of the option to designate these as financial liabilities at fair value through profit or loss upon initial recognition.

M+M does not use derivative financial instruments.

#### **Inventory**

The valuation of the inventory depends on the regulations of IAS 2. This position contains mainly finished goods which are capitalized at cost. If necessary, an inventory valuation adjustment is made due to a reduced usability. All recognizable risks are considered by appropriate adjustments.

#### **Income taxes**

Income taxes include current income taxes payable as well as deferred taxes. Tax liabilities mainly comprise liabilities for domestic and foreign income taxes. They include liabilities for the current period as well as for prior periods. The liabilities are measured based on the applicable tax law in the countries where M+M operates and include all facts of which the Company is aware.

Deferred tax assets and liabilities are recognized for temporary differences between the carrying amounts in the consolidated balance sheet and the tax base, as well as for tax loss carry forwards. Deferred tax assets are recognized to the extent that it is probable that future taxable profit will be available against which the temporary differences can be utilized. Deferred tax is not recognized if it arises from the initial recognition of an asset or liability in a transaction other than a business combination that at the time of the transaction affects neither accounting nor taxable profit or loss.

Deferred tax liabilities are recognized on planned dividend payments by subsidiaries. Where a dividend payment is not planned for the long term, no deferred tax liability is recognized on the difference between the proportionate net assets according to IFRS and the tax base of the investment in the subsidiary.

Currently enacted tax laws and tax laws that have been substantively enacted as of the balance sheet date are used as the basis for measuring deferred taxes.

#### **Borrowing costs**

In accordance with IAS 23, borrowing costs are charged to expenditure.

If the construction phase of property, plant or equipment extends over a long period, the interest incurred on borrowed capital up to the date of completion is capitalized as part of the cost of acquisition or construction (Borrowing Costs).

#### **Government grants**

Government grants compensating expenses are recognized in profit or loss as other operating income in the period in which the related expenses incurred.

#### **Equity costs**

According to IAS 32 the costs for the capital increase are offset with the additional paid in capital.

#### **Accruals**

Pursuant to IAS 37, accruals are to be reported at the amount resulting from the best estimate of the financial outflow required to meet current obligations as at the balance sheet date.

The value stated for other accruals takes into account all identifiable risks based on past experience and where the scope and maturity is uncertain.





### Pension accruals

The pension accruals mainly exist at the parent company and refer to a defined benefit plan for the Managing Directors. The pension commitment contains a retirement pay, a widow's pension as well as a disablement pension. In the case of pension, the payments are made monthly in advance. Pursuant to the Projected Unit Credit Method according to IAS 19 the pension accruals are measured at the present value of the defined benefit liability and cover all benefits after termination of employment.

The calculations were based on the following assumptions:

	2024	2023
Discount rates	3.40%	3.20%
Estimated return on plan assets	2.00%	2.00%
Future changes in Remunerations	1.64%	1.64%

The amount of the pension obligations was determined using actuarial principles using biometric data. The provision is reduced by the amount of the plan assets which consist of pension liability insurances. The service cost is disclosed in staff costs and other comprehensive income.

The actuarial gains and losses arising from two defined benefit plans are recognized in other comprehensive income.

### Other assets and liabilities

For all identifiable risks of other assets, appropriate allowances are taken.

Liabilities are valued at their repayment value.

### Foreign currency assets and liabilities

In the individual financial statements, assets and liabilities are translated at the rate on the balance sheet date. Profits and losses from the translation of foreign currency receivables and liabilities are reported in the Statement of Income under the financial result. As the income and expenses are not substantial, there are no notes relating to this position.

### Principles of revenue recognition

Revenue from the sale of products (software) and other related services is recognised when the customer obtains control of them.

MuM recognises revenues from services, especially maintenance contracts, over a specific period of time, since the customer receives the benefit from the Group's services and simultaneously utilises this benefit.

Revenue from the sale of software is recognised at a specific point in time, generally upon delivery.

M+M usually issues invoices with payment terms of less than 60 days.

For sales transactions with several partial services, such as the sale of products and related services or maintenance agreements, sales are allocated to the various services mainly on the basis of their estimated relative individual sales prices.

The Group pays its employees sales commissions for each contract they win for the bundled sale of software and services. These additional costs of initiating a contract are recognised immediately as an expense when they are incurred if the amortisation period would not exceed one year.

### Deferred revenue

If a customer pays a consideration before the Group transfers goods or services to it, a deferred revenue item is recognised when the payment is made or becomes due. Deferred revenues are recognised as revenue as soon as the Group meets its contractual obligations.

### Related parties

M+M's Main Shareholder, Chairman of the Board and Managing Director Adi Drotleff and members of his family granted M+M loans amounting to KEUR 2,439 (PY: 2,694) as of Dec 31, 2024 and therefore received interest in 2024 of KEUR 50 (PY: 72).

## Notes on the statement of income

### 1. Revenues

Group sales are generated exclusively from contracts with customers within the meaning of IFRS 15.

Revenues from contracts with customers in the reporting period consisted of service obligations fulfilled at a specific point in time of KEUR 275,198 (PY: 273,588) and service obligations fulfilled over a specific period of KEUR 50,646 (PY: 48,718). Revenues of KEUR 5,028 (PY: 4,791) were recorded, which were included in deferred revenues in the previous period.

### 2. Cost of materials

Amounts in KEUR	2024	2023
Cost of materials	-137,406	-139,931
Costs of outstanding services	-2,308	-3,067
Licences in other production costs for proprietary Software	-11,540	-10,774
	<b>-151,254</b>	<b>-153,772</b>

### 3. Personnel expenses

Amounts in KEUR	2024	2023
Wages and salaries	-86,496	-82,372
Social security	-17,020	-15,729
Share based payments	-172	-172
Pension costs and welfare	-360	-354
Training costs	-762	-733
	<b>-104,810</b>	<b>-99,360</b>

### 4. Other operating expenses

Amounts in KEUR	2024	2023
Insurance	-819	-750
Costs of buildings	-2,022	-1,632
Travel costs	-3,684	-3,154
Car expenses	-3,160	-3,110
Advertising and promotion	-3,606	-3,405
Communication	-1,198	-954
IT costs	-3,827	-2,782
Consulting and Lawyer fees	-1,910	-1,614
Rest of other operating expenses	-1,986	-1,887
	<b>-22,212</b>	<b>-19,288</b>

The item 'Rest of other operating expenses' consist of various items less than KEUR 300.

### 5. Depreciation and Amortization

Amounts in KEUR	2024	2023
Depreciation of property, plant and equipment	-2,332	-2,211
Depreciation of other intangible assets	-1,631	-1,246
Amortization due to purchase price allocated intangible assets	-517	-517
Depreciation finance lease	-5,783	-5,833
	<b>-10,263</b>	<b>-9,807</b>

**6. Other operating income**

<b>Amounts in KEUR</b>	<b>2024</b>	<b>2023</b>
Return from private use of cars and telephone	1,756	1,721
Rents received	254	260
Marketing funds	1,274	1,264
Development grants	708	0
Capitalized own contributions for internal IT projects	1,100	2,200
Capitalized own contributions for software product development	3,100	0
Other income	4,078	1,307
	<b>9,170</b>	<b>6,752</b>

The item 'Other income' consist of various items, all of which are less than KEUR 300.

**7. Financial result**

<b>Amounts in KEUR</b>	<b>2024</b>	<b>2023</b>
Interest income	466	201
Interest expenses	-322	-552
Income from investments and participations	9	21
Minority interest in VAR business partners	-158	-127
Other income and expenses	-434	-396
Interest for finance lease IFRS16	-170	-165
Foreign currency exchange gains / losses	-333	-590
<b>Financial result</b>	<b>-942</b>	<b>-1.608</b>

**8. Taxes on income**

This item encompasses actual tax expenses amounting to KEUR 10,469 (PY: 11,474), a relief amounting to KEUR 245 (PY: relief 114) from further development and revaluation of deferred tax assets, as well as a charge of KEUR 1,874 (PY: relief 1,708) from deferred tax liabilities.

The non permanent differences include deferred tax assets amounting to KEUR 1,314 (PY: 1,046) resulting from different valuations of accruals, as well as deferred tax liabilities

amounting to KEUR 7,299 (PY: 5,422), mainly resulting from the capitalization of development costs.

The average domestic tax rate contains the corporate income tax ("Körperschaftsteuer") plus solidarity surcharge ("Solidaritätszuschlag") as well as the trade tax ("Gewerbesteuer").

The transition between the expected taxes and the actual tax proceeds are explained by the reconciliation in the following table:

<b>✘ Tax reconciliation</b>		
<b>Amounts in KEUR</b>	<b>2024</b>	<b>2023</b>
<b>Result before income tax</b>	<b>45,533</b>	<b>45,223</b>
Average domestic tax rate	30%	30%
<b>Expected tax charge</b>	<b>-13,660</b>	<b>-13,567</b>
<b>Tax rate variances</b>		
Domestic and foreign tax rate differential	1.435	662
<b>Deviation of the taxable base from</b>		
Non-period income tax	226	76
Non deductible expenses	-331	-466
Tax free income from investments	0	7
Tax-free grants	248	0
<b>Valuation of deferred tax assets</b>		
Non-recognition of deferred tax assets	-16	-8
<b>Actual tax charge</b>	<b>-12,098</b>	<b>-13,296</b>
<b>Effective tax rate in percent</b>	<b>26.57%</b>	<b>29.40%</b>

### 9. Calculation of shares outstanding and earnings per share

In accordance with IAS 33, a weighted average was calculated for shares outstanding. The diluted number of shares does not only include the original subscribed capital shares, but also all option rights from the employee option program which were exercisable at the statement closing date, but which had not yet been exercised.

The number of shares in treasury stock are included in the calculation of earnings per share.

	<b>2024</b>	<b>2023</b>
Net result in KEUR	30,487	28,867
Weighted number of shares	16,907,847	16,772,959
Earnings per share EUR	1.8031	1.7210

The diluted and undiluted number of shares as well as the net result is identical.

## Notes on the balance sheet

### Assets

#### Current assets

##### 10. Trade accounts receivable

Trade accounts receivable comprised in the group's individual companies include reasonable adjustments and generally have a remaining term of less than one year.

The receivables are reduced by allowance amounting to KEUR 1,027 (PY: 1,010).

With respect to the trade receivables that are neither impaired nor past due, there are no indications as of the reporting date that the debtors will not meet their payment obligations.

The following table shows the development of allowances on trade receivables:

Amounts in KEUR	2024	2023
Allowances as of Jan 1	1,010	1.345
Translation differences	3	6
Addition	290	224
Disposal	-108	-412
Reversing	-168	-153
<b>Allowances as of Dec 31</b>	<b>1,027</b>	<b>1,010</b>

In the current and the prior year no material expenses for the full write-off of trade receivables as well as income from recoveries on trade receivables written off occurred.

All income and expenses relating to allowances and write-offs of trade receivables are reported under other operating expenses.

##### 11. Inventories

This position predominantly contains purchased goods amounting to KEUR 8,080 (PY: 5,275), software licenses amounting to KEUR 0 (PY: 2) and work in process amounting to KEUR 356 (PY: 263). As in the previous year allowances have not been made.

##### 12. Other current assets

This position primarily comprises tax credits, loans and creditor receivables from pending reimbursements.

##### Non current assets

The development of the non current assets is indicated in the fixed assets register.

The column 'Others' includes reclassifications, write-ups as well as consolidation effects.

Trade receivables							
Amounts in KEUR	Book value	of which neither impaired nor past due on the reporting date	of which not impaired on the reporting date and past due in the following periods				
			30 < 60	60 < 90	90 < 180	180 < 360	> 360
As of Dec 31, 2024	35,171	31,071	1,530	879	1,154	537	0
As of Dec 31, 2023	40,903	38,181	1,296	518	571	337	0



## Fixed assets register 2023

	Acquisition costs						Accumulated depreciation						Net book value	
	Jan 01, 23	Others	Currency	Addition	Disposal	Dec 31, 23	Jan 01, 23	Others	Currency	Addition	Disposal	Dec 31, 23	Jan 01, 23	Dec 31, 23
<b>I. Tangible assets</b>	16,118	35	100	2,553	-1,355	17,451	11,259	35	104	1,813	-1,278	11,933	4,859	5,518
<b>II. Property</b>	21,623	0	8	526	0	22,157	4,063	0	10	398	0	4,471	17,560	17,686
<b>III. Other intangible assets</b>	52,199	33	49	3,870	-1,760	54,391	32,255	33	37	1,763	-1,707	32,381	19,944	22,010
1. Development costs	12,168	0	0	500	0	12,668	6,673	0	0	726	0	7,399	5,495	5,269
2. Purchase price allocation	22,392	0	0	0	0	22,392	17,191	0	0	517	0	17,708	5,201	4,684
3. Other	17,639	33	49	3,370	-1,760	19,331	8,391	33	37	520	-1,707	7,274	9,248	12,057
<b>IV. Goodwill</b>	54,185	0	0	0	0	54,185	6,311	0	0	0	0	6,311	47,874	47,874
<b>V. Financial assets</b>	31	0	0	5	0	36	0	0	0	0	0	0	31	36
<b>VI. Right of use leasing contracts</b>	22,889	0	252	5,903	-4,214	24,830	11,549	0	170	5,833	-4,212	13,340	11,340	11,490
(all amounts in KEUR)	167,045	68	409	12,857	-7,329	173,050	65,437	68	321	9,807	-7,197	68,436	101,608	104,614

### 13. Goodwill

The development of goodwill is shown in the Goodwill register.

All acquired companies within the 'market offensive' in Germany, Austria and Switzerland are summarized under 'VAR Business D/A/CH'.

### 14. Leasing

MuM has leasing contracts in place for office space, vehicles, operating and business equipment and software. Leasing agreements for vehicles, operating and office equipment and software generally have terms of between 3 and 5 years, while the term for office rent is usually between 2 and 10 years.

The following table shows the leasing liabilities and the changes during the reporting period:

Amounts in KEUR	2024	2023
As of Jan 1	11,626	11,473
Addition	5,753	5,906
Interest	170	165
Payment	-5,781	-5,827
Currency	-207	-91
<b>As of Dec 31</b>	<b>11,561</b>	<b>11,626</b>
thereof short term	5,162	4,904
thereof long term	6,399	6,722

### Goodwill development

Amounts in KEUR	Dec 31, 2023	Addition / Impairment	Currency	Dec 31, 2024
VAR Business D/A/CH	16,214			16,214
SOFISTiK	13,196			13,196
OPEN MIND	10,733			10,733
M+M UK	2,982			2,982
M+M Romania	1,610			1,610
DATAflor	1,216			1,216
M+M Italy	1,116			1,116
M+M Poland	474			474
M+M France	333			333
<b>Total</b>	<b>47,874</b>			<b>47,874</b>

### Fixed assets register 2024

	Acquisition costs						Accumulated depreciation						Net book value	
	Jan 01, 24	Others	Currency	Addition	Disposal	Dec 31, 24	Jan 01, 24	Others	Currency	Addition	Disposal	Dec 31, 24	Jan 01, 24	Dec 31, 24
<b>I. Tangible assets</b>	17,451	-11	19	1,844	-1,958	17,345	11,933	-65	-2	1,926	-1,863	11,929	5,518	5,416
<b>II. Property</b>	22,157	20	20	20	-9	22,208	4,471	0	21	406	-9	4,889	17,686	17,319
<b>III. Other intangible assets</b>	54,391	-194	-6	8,454	-101	62,544	32,381	-123	-8	2,148	-101	34,297	22,010	28,247
1. Development costs	12,668	0	0	3,600	0	16,268	7,399	0	0	661	0	8,060	5,269	8,208
2. Purchase price allocation	22,392	0	0	0	0	22,392	17,708	0	0	517	0	18,225	4,684	4,167
3. Other	19,331	-194	-6	4,854	-101	23,884	7,274	-123	-8	970	-101	8,012	12,057	15,872
<b>IV. Goodwill</b>	54,185	0	0	0	0	54,185	6,311	0	0	0	0	6,311	47,874	47,874
<b>V. Financial assets</b>	36	0	0	1	-5	32	0	0	0	0	0	0	36	32
<b>VI. Right of use leasing contracts</b>	24,830	0	-74	5,753	-4,862	25,647	13,340	0	-33	5,783	-4,861	14,229	11,490	11,418
(all amounts in KEUR)	173,050	-185	-41	16,072	-6,935	181,961	68,436	-188	-22	10,263	-6,834	71,655	104,614	110,306

The cash outflows for leases amounted to KEUR 5,781 (PY: 5,827), while non-cash additions of rights of use and lease liabilities amounted to KEUR 5,753 (PY: 5,906).

The maturity analysis of the leasing liabilities is shown under the item "Liquidity risks" on page 60.

The following amounts were recognised in profit or loss in the reporting period:

Amounts in KEUR	2024	2023
Depreciation leasing	5,783	5,833
Interest for finance lease	170	165
<b>Total amount recognized in profit and loss</b>	<b>5,953</b>	<b>5,998</b>

The weighted average marginal borrowing rate used for the recognition of lease liabilities is 1.5%.

### Development right of use leasing 2024

Amounts in KEUR	Jan 1, 2024	Addition/Disposal	Depreciation	Currency	Dec 31, 2024
Offices	6,991	2,302	-2,624	-10	6,659
Cars	3,469	2,160	-2,080	-26	3,523
Equipment	150	36	-61	0	125
Software	874	1,255	-1,018	0	1,111
<b>Total</b>	<b>11,484</b>	<b>5,753</b>	<b>-5,783</b>	<b>-36</b>	<b>11,418</b>

### Development right of use leasing 2023

Amounts in KEUR	Jan 1, 2023	Addition/Disposal	Depreciation	Currency	Dec 31, 2023
Offices	7,059	2,441	-2,556	47	6,991
Cars	2,628	2,750	-1,933	24	3,469
Equipment	94	132	-76	0	150
Software	1,559	583	-1,268	0	874
<b>Total</b>	<b>11,340</b>	<b>5,906</b>	<b>-5,833</b>	<b>71</b>	<b>11,484</b>

## Liabilities

### Current liabilities

#### 15. Short term debt and current portion of long term debt

This position almost exclusively contains bank loans at principal banks in Germany and abroad in the context of credit lines. They are partly secured by assignments of receivables.

In the balance sheet, the bank liabilities classified as current are those which have to be paid back within the next 12 months. Fixed credit lines with indefinite durations are classified as non current, even if they are refinanced on a short term base (low interest rates). This increases the clarity of the financing structure, and avoids the wrong impression that most of the bank debt would be short-term.

A liquidity reserve in the form of credit lines and, where necessary, cash is maintained to guarantee the solvency and financial flexibility of M+M at all times. For this purpose, the Company entered into credit agreements with various international and domestic banks amounting to a total of EUR 34.0 million (PY: 38.0). M+M does not pay commitment fees on unused credit lines

#### 16. Accrued expenses

Accruals are calculated by taking all identifiable risks into account and always represent the expected repayment amount.

The development of the accruals in the reporting period is shown in the table of accrual development.

The other non current accruals mainly include provisions for archiving.

❖ Table of accrual development				
Amounts in KEUR	Dec 31, 2023	Disposal	Addition	Dec 31, 2024
Personnel accruals	11,417	-7,425	6,475	10,467
Outstanding bills	823	-820	1,023	1,026
Other	943	-220	189	912
<b>Total current accruals</b>	<b>13,183</b>	<b>-8,465</b>	<b>7,687</b>	<b>12,405</b>
Other accruals	80	0	0	80
<b>Total non current accruals</b>	<b>80</b>	<b>0</b>	<b>0</b>	<b>80</b>
<b>Total accruals</b>	<b>13,263</b>	<b>-8,465</b>	<b>7,687</b>	<b>12,485</b>

**17. Other current liabilities**

This position includes debts from VAT and tax on wages and salaries, outstanding social security costs and deferred income.

**Non current liabilities****18. Long term debt, less current portion**

This position contains the fixed and unsecured credit lines with indefinite period of redemption, shareholder loans as well as bank loans for financing properties secured by mortgages.

**19. Long-term trade accounts payable**

This item contains liabilities to Autodesk from multi-year contracts that are not due in the current financial year.

<b>Debt</b>				
Amounts in KEUR	Total	within 1 year	due > 1 year < 5 years	due > 5 years
<b>As of Dec 31, 2024</b>				
Debt	5,105	2,647	2,458	0
Real estate financing secured by mortgage	2,466	366	1,068	1,032
<b>Financial liability</b>	<b>7,571</b>	<b>3,013</b>	<b>3,526</b>	<b>1,032</b>
<b>As of Dec 31, 2023</b>				
Debt	4,742	2,010	2,732	0
Real estate financing secured by mortgage	2,830	365	1,334	1,131
<b>Financial liability</b>	<b>7,572</b>	<b>2,375</b>	<b>4,066</b>	<b>1,131</b>

<b>Changes in liabilities arising from financing activities</b>					
Amounts in KEUR	As of	Cash Flow	Currency	Other	As of
	<b>Jan 1, 2024</b>				<b>Dec 31, 2024</b>
Short term debt and current portion of long term debt	2,375	638	0	0	3,013
Long term debt, less current portion	2,732	-273	0	0	2,459
Real estate financing secured by mortgage	2,465	-366	0	0	2,099
<b>Financial liability</b>	<b>7,572</b>	<b>-1</b>	<b>0</b>	<b>0</b>	<b>7,571</b>
	<b>Jan 1, 2023</b>				<b>Dec 31, 2023</b>
Short term debt and current portion of long term debt	12,095	-9,723	3	0	2,375
Long term debt, less current portion	11,462	-8,730	0	0	2,732
Real estate financing secured by mortgage	2,830	-365	0	0	2,465
<b>Financial liability</b>	<b>26,387</b>	<b>-18,818</b>	<b>3</b>	<b>0</b>	<b>7,572</b>

## 20. Pension accrual

The pension accruals essentially exist at the parent company and refer to a defined benefit plan for the Managing Directors. The pension commitment contains a retirement pay, a widow's pension as well as a disability pension.

The pension accruals are determined according to actuarial principles of the projected unit credit method in accordance with IAS 19.

The pension accruals at the balance sheet date amount to KEUR 85 (PY: 148), of which an amount of KEUR 85 (PY: 148) represents the determined cash value of the performance-oriented obligation not financed via funding.

The cash value determined as at the balance sheet date of the performance-oriented obligations financed via funds amounts to KEUR 2,547 (PY: 2,593). This figure also corresponds to the fair value of the plan assets as at the balance sheet date. The Statement of Income includes income from plan assets amounting to KEUR 89 (PY: 36), interest expenses amounting to KEUR 94 (PY: 102) and current time of service expenditure amounting to KEUR 0 (PY: 0).

The stated expenses and income are included in the personnel expenses and the financial result.

The recognition of actuarial gains and losses are shown in total in other comprehensive income (see notes to the pension accruals on page 47).

In the financial year, pension has been paid in the amount of KEUR 150 (PY: 150).

The reconciliation to the net recognized liability is as follows:

<b>Amounts in KEUR</b>	<b>2024</b>	<b>2023</b>
Benefit obligation at start of the year	2,741	2,684
Interest cost	94	102
Benefits paid	-150	-150
Net actuarial gain	-53	105
<b>Benefit obligation at end of year</b>	<b>2,632</b>	<b>2,741</b>
Plan assets at start of year	2,593	2,635
Received contributions	-150	-150
Actual return on plan assets	89	36
Net actuarial gain	15	72
<b>Plan assets at end of year</b>	<b>2,547</b>	<b>2,593</b>
<b>Net recognized liability</b>	<b>85</b>	<b>148</b>



Pension benefits payable in the future are estimated as follows:

Year	Amounts in KEUR
2025	182
2026	194
2027	197
2028	200
2029	206
2030 - 2034	1,064

The benefit obligation has an average statistical expected remaining life of 12 years (PY: 13).

The table below shows the sensitivity of pension accruals on changes in the parameters:

Amounts in KEUR	2024	2023
Change in discount rate +0.5%	-104	-115
Change in discount rate -0.5%	115	126
Change in projected future benefit increases +0.5%	31	31
Change in projected future benefit increases -0.5%	-28	-29
Change in life expectancy + 1 year	70	72

When calculating the sensitivity of the DBO to significant assumptions, the same method has been applied as when calculating the pension liability recognised in the statement of financial position. The above sensitivity analysis are based on a change in one assumption while holding all other assumptions constant.

## Shareholders' equity

### 21. Share capital

The subscribed capital of M+M SE as of Dec 31, 2024, comprised 17,149,052 (PY: 17,149,052) shares, with a calculated stake of EUR 1.00 per share.

As of Dec 31, 2024 the approved capital amounts to KEUR 3,430 (PY: 3,430). It was authorized by the general meeting on May 11, 2023 and expires on May 11, 2028.

### 22. Capital reserve

The development of the capital reserve is shown by the following table:

Amounts in KEUR	2024	2023
Capital reserve as of Jan 1	47,160	46,588
Share dividend	2,457	1,603
Delivery of own shares	148	33
Acquisition of additional shares of already fully consolidated companies	-466	-1,064
<b>Capital reserve as of Dec 31</b>	<b>49,299</b>	<b>47,160</b>

### 23. Treasury stock

In the year 2024 M+M acquired 171,085 (PY: 11,576) M+M shares at a total amount of KEUR 9,157 (PY: 530) or EUR 53.53 (PY: 45.81) per share.

In the financial year, 162,592 (PY: 163,288) treasury shares with a total book value of KEUR 6,837 (PY: 6,741) or EUR 42.05 (PY: 41.28) per share were used to service the stock dividend at a price of EUR 57.17 (PY: 51.11) per share and a total amount of KEUR 6,837 (PY: 6,741). The capital gain of KEUR 2,457 (PY: 1,603) was recorded in capital reserves.

For the employee participation program 19,786 (PY: 19,818) treasury shares were used at a total amount of KEUR 1,047 (PY: 852) or EUR 52.90 (PY: 43.00) per share. The amount of the discount granted to employees of KEUR 209 (PY: 172) was recognized as personnel expenses (see page 48).

In the prior year 14,063 treasury shares had been exchanged of non-voting preference shares of SOFiSTiK AG at a price of EUR 55.00 and a total amount of KEUR 773.

In 2024 the shares of treasury stock reduced on balance by 45,552 (PY: 185,593) shares and KEUR 518 (PY: 7,609) has been realized.

As of Dec 31, 2024, M+M held 249,776 (PY: 295,328) shares of treasury stock. This is 1.46% (PY: 1.72%) of the issued capital.

Treasury shares are carried at cost amounting to KEUR 11,726 (PY: 12,244) or EUR 46.94 (PY: 41.46) per share. According to IFRS they are treated in the balance sheet like retired shares and must be deducted from equity.

**Notes on the cash flow statement**

The cash flow statement classifies cash flows according to operating, investing and financing activities. Cash and cash equivalents in the cash flow statement correspond to total cash and cash equivalents on the balance sheet. This position contains cash in form of liquid funds and sight deposit accounts as well as cash equivalents consisting of fixed term deposits and money market papers, which can be transferred into cash at any time and therefore are suspended from substantial interest or currency risks.

Flows of funds from the acquisition and sale of consolidated companies are included in cash flows from investing activities. Effects of foreign exchange rate changes are stated separately.

Among other items, cash flows from operating activities include:

- KEUR 10,651 (PY: 15,298) paid for taxes on income (net of income tax refunds)
- cash flows from investments (dividends) amounting to KEUR 9 (PY: 21)

The other non cash expenses / income are mainly the change of the deferred taxes amounting to KEUR 1,609 (PY: 1,794), the change of deferred revenues of KEUR 1,156 (PY: 237) and the change of the other comprehensive income of KEUR 147 (PY: 68).

In the cash flows from financing activities dividends to M+M shareholders amounting to KEUR 27,771 (PY: 23,335) or EUR 1.65 (PY: 1.40) per share are included of which KEUR 9,293 (PY: 8,344) was contributed back to equity since the option share dividend was chosen. The actual total payment to M+M shareholders was KEUR 18,478 (PY: 14,991).

There are no restrictions on the disposal of cash and cash equivalents.

**Other supplementary information****Other financial obligations and contingent liabilities**

Until Dec 31, 2018 the other financial obligations were mainly the result of long term rental and operating lease contracts for the group as a whole.

Since January 1, 2019 these are recognised in the balance sheet as rights of use according to IFRS 16. There were no further relevant other financial obligations as of Dec 31, 2024.



## Risk management

### Principles of risk management

M+M is exposed in particular to risks from movements in exchange and interest rates, as well as liquidity, other price and credit risks that affect its assets, liabilities, and forecast transactions.

Financial risk management aims to limit these risks through ongoing operational and finance activities.

### Currency risk

M+M is exposed to currency risks from its investing and operating activities. Usually foreign currencies are not hedged. The individual Group entities predominantly execute their operating activities in their respective functional currencies. This is why the assessment of exchange rate risk from ongoing operations is low.

The following table demonstrates the sensitivity to a reasonable possible change in the EURO exchange rate to all other currencies, with all other variables held constant, of the Group's profit before tax (due to changes in the fair value of monetary assets and liabilities).

Amounts in KEUR	2024	2023
Increase of 5%	-650	-423
Decrease of 5%	650	423

### Interest risk

Interest rate risks are presented by way of sensitivity analyses in accordance with IFRS 7. These show the effects of changes in market interest rates on interest payments, interest income and expense.

Changes in the market interest rates of non-derivative financial instruments with fixed interest rates only affect income if these are measured at their fair value. As such, all financial instruments with fixed interest rates that are carried at amortized cost are not subject to interest rate risk as defined in IFRS 7.

The following table demonstrates the sensitivity to a reasonable possible change in interest rates, with all other variables held constant, of the Group's profit before tax and shareholders equity (through the impact on floating rate borrowings).

Amounts in KEUR	2024	2023
Increase of 25 basis points	-9	-6
Decrease of 25 basis points	9	6

**Liquidity risks**

The following tables show contractually agreed (undiscounted) interest payments and maximum possible repayments of the non-derivative financial liabilities:

The variable interest payments arising from the financial instruments were calculated using the last interest rates fixed before the balance sheet date. Financial liabilities that can be repaid at any time are always assigned to the earliest possible time period.

**❖ Liquidity risk 2024**

Amounts in KEUR	Book value	Cash flows 2025		Cash flows 2026		Cash flows from 2027	
	Dec 31, 2024	Interest rate	Repayment	Interest rate	Repayment	Interest rate	Repayment
Bank debt	5,312	27	3,012	22	387	93	1,733
Shareholders' loan	2,439		2,439				
Trade accounts payable	49,707		33,414		16,293		
Other current liabilities	3,482		3,482				
Finance lease obligation	11,561		5,162		2,909		3,490

**❖ Liquidity risk 2023**

Amounts in KEUR	Book value	Cash flows 2024		Cash flows 2025		Cash flows from 2026	
	Dec 31, 2023	Interest rate	Repayment	Interest rate	Repayment	Interest rate	Repayment
Bank debt	4,879	33	2,374	27	386	115	2,119
Shareholders' loan	2,694		2,694				
Trade accounts payable	28,530		28,530				
Other current liabilities	3,849		3,849				
Finance lease obligation	11,626		4,904		3,055		3,667

All instruments held at balance sheet date were included. Planning data for future, new liabilities is not included. Amounts in foreign currency were each translated at the closing rate at the reporting date.

The expected future outflow of cash is covered by the operating business, the trade accounts receivables as well as the available credit lines.

The following table shows the carrying amounts and fair values of financial assets and liabilities by category of financial instrument and reconciliation to the corresponding line item in the balance sheet.

Since the line items 'Other receivables' and 'Other liabilities' contain both financial instruments and non-financial assets and liabilities (such as other tax receivables or advance payments for services to be received in the future), the reconciliation is shown in the column headed 'Non-financial assets / liabilities'.

As a matter of principle the fair value is determined on the hierarchic level 2 with consideration of prices not noted or indirectly derived from prices noted on active markets.

<b>Fair Values 2024</b>						
<b>Amounts in KEUR</b>						
	<b>Category in accordance with IFRS 9</b>	<b>Book value Dec 31, 2024</b>	<b>Fair Value Dec 31, 2024</b>	<b>Amounts recognized in balance sheet according to IFRS9 Amortized cost</b>	<b>non-financial assets / liabilities</b>	<b>Book value on balance sheet Dec 31, 2024</b>
<b>Assets</b>						
Cash and cash equivalents	AC	42,997	42,997	42,997		42,997
Trade accounts receivables	AC	35,171	35,171	35,171		35,171
Other current assets	AC	3,311	3,311	3,311	10,357	13,668
<b>Liabilities</b>						
Bank debt	AC	5,132	4,982	5,132		5,132
Shareholders' loan	AC	2,439	2,439	2,439		2,439
Trade accounts payable	AC	49,707	49,707	49,707		49,707
Other current liabilities	AC	3,482	3,482	3,482	3,666	7,148
<b>Of which aggregated by category in accordance with IFRS 9</b>						
Financial assets measured at fair value through profit or loss	AC	81,479	81,479	81,479		
Financial Liabilities Measured at Amortised Cost (FLAC)	AC	60,760	60,610	60,760		

<b>Fair Values 2023</b>						
<b>Amounts in KEUR</b>						
	<b>Category in accordance with IFRS 9</b>	<b>Book value Dec 31, 2023</b>	<b>Fair Value Dec 31, 2023</b>	<b>Amounts recognized in balance sheet according to IFRS9 Amortized cost</b>	<b>non-financial assets / liabilities</b>	<b>Book value on balance sheet Dec 31, 2023</b>
<b>Assets</b>						
Cash and cash equivalents	AC	24,867	24,867	24,867		24,867
Trade accounts receivables	AC	40,903	40,903	40,903		40,903
Other current assets	AC	2,416	2,416	2,416	7,819	10,235
<b>Liabilities</b>						
Bank debt	AC	4,879	4,675	4,879		4,879
Shareholders' loan	AC	2,694	2,694	2,694		2,694
Trade accounts payable	AC	28,530	28,530	28,530		28,530
Other current liabilities	AC	3,849	3,849	3,849	5,076	8,925
<b>Of which aggregated by category in accordance with IFRS 9</b>						
Financial assets measured at fair value through profit or loss	AC	68,186	68,186	68,186		
Financial Liabilities Measured at Amortised Cost (FLAC)	AC	39,952	39,748	39,952		



Cash and cash equivalents, and trade and other receivables mainly have short times to maturity. For this reason, their carrying amounts at the reporting date approximate the fair values.

Trade and other payables, as well as other liabilities, generally have short times to maturity; the values reported approximate to the fair values.

The fair values of unquoted bonds, liabilities to banks, promissory notes, and other financial liabilities are calculated as the present values of the payments associated with the debts, based on the applicable yield curve.

#### **Other price risks**

As part of the presentation of market risks, IFRS 7 also requires disclosures on how hypothetical changes in risk variables affect the price of financial instruments. Important risk variables are stock exchange prices or indexes.

As of December 31, 2024, M+M did not hold any material investments to be classified as 'available-for-sale'.

#### **Credit risk**

M+M trades only with recognized, credit-worthy third parties. It is the Group's policy that all customers who wish to trade on credit terms are subject to credit verification procedures. In addition, receivable balances are monitored on an ongoing basis with the result that the exposure to bad debts is not significant. The maximum exposure is the carrying amount.

There are no significant concentrations of credit risk. With respect to credit risk arising from the other financial assets, which comprise cash and cash equivalents, available-for-sale financial investments, loan notes and certain derivative instruments, the exposure to credit risk arises from default of the counterparty, with a maximum exposure equal to the carrying amount of these instruments.

Credit risks are handled with specific and lump-sum allowances as well as a credit sale insurance. The credit sale insurance covers 70% to 90% of the insured receivable in the case of loss of receivables outstanding. Because of the structure of our customers there are no significant concentrations of credit risk



### Capital management

The primary objective of the capital management of M+M was to ensure that it maintains a strong credit rating and healthy capital ratio in order to support its business and maximize shareholder value. M+M's policy is to keep an equity ratio of at least 30%.

Above that the gearing ratio should be below 3 times EBITDA.

The gearing ratio of -0.70 (PY: -0.39) and the equity ratio of 49.91% (PY: 53.29%) are within the objectives.

To maintain or adjust the capital structure, the Group may adjust the dividend payment to shareholders or issue new shares. No changes were made to the objectives, policies and methods as of December 31, 2024.

### Research and development expenses

The research and development expenses for the financial year amounted to KEUR 26,713 (PY: 24,908).

Thereof EUR 3,600 (PY: 500) was capitalized as development cost for individual projects under other intangible assets, because their future recoverability could reasonably be assured.

### Employees

The group's average number of employees (full time equivalent) during the fiscal year was 1,095 (PY: 1,056).

### Administrative Board

The Administrative Board consist of the following persons:

*Adi Drotleff*, Diplom-Informatiker, Munich (Chairman)

*Heike Lies*, Magister Artium, Munich, Municipal employee (Deputy Chairwoman)

*Dr. Rupprecht von Bechtolsheim*, independent attorney, Munich

According to article 23 and 24 of the SE implementing law in connection with article 10, para 1, of the articles of association of Mensch und Maschine Software SE, the Administrative Board is made up of three members and is elected for 5 years. The last election was on May 11, 2021.

### Managing Directors

The following gentlemen were Managing Directors during fiscal year 2024:

*Adi Drotleff*, Diplom-Informatiker, Munich (Strategy/Communication)

*Markus Pech*, Betriebswirt (FH), Schrobenhausen (CFO)

The company is legally represented by two Managing Directors or by one Managing Director together with a person authorized to sign. Mr. Adi Drotleff has sole representation authorization.

### Remuneration of Managing Directors and Administrative Board

The remuneration for the Managing Directors in 2024 amounted to KEUR 783 (PY: 737). It was composed of fixed salaries of KEUR 321 (PY: 312), variable components of KEUR 416 (PY: 378) and non-cash salary components of KEUR 46 (PY: 47).

The pension obligation for the Managing Directors amounted to KEUR 1,626 (PY: 1,771) as of December 31, 2024.

Remuneration for the Administrative Board in 2024 totaled KEUR 24 (PY: 24).

### Audit fees

The required disclosure of the group auditor's fee volume is as follows:

Amounts in KEUR	2024	2023
Audit	246	231
Tax consulting	112	52
<b>Total</b>	<b>358</b>	<b>283</b>

**Appropriation of retained earnings of  
Mensch und Maschine Software SE**

Mensch und Maschine Software SE has unappropriated retained earnings amounting to KEUR 36,783 as of December 31, 2024.

The administrative board will propose to the shareholders meeting a dividend of EURO 1.85 per share for fiscal year 2024. With consideration of the 399.776 shares in treasury stock acquired till February 24, 2025, the total dividend payment amounts to KEUR 30,986. The remaining balance of KEUR 5,797 is carried forward.

If the number of shares in treasury stock should change before the shareholders' meeting on May 8, 2025, the dividend payment will be adapted accordingly.



**“INDEPENDENT AUDITOR’S REPORT****to the Mensch und Maschine Software SE:****Audit Opinions**

We have audited the consolidated financial statements of Mensch und Maschine Software SE and its subsidiaries (the Group) - consisting of consolidated balance sheet as at December 31, 2024, the consolidated profit and loss statement and the consolidated statement of comprehensive income, the consolidated statement of changes in equity, the consolidated cash flow statement for the financial year from January 1 to December 31, 2024, and the notes to the consolidated financial statements, including material accounting policy information. In addition, we have audited the group management report of Mensch und Maschine Software SE for the financial year from January 1 to December 31, 2024.

In accordance with the German legal requirements, we have not audited the following content of the group management report:

- the presentation of the non-financial performance indicators contained in the group management report on pages 16 and 17
- all examples of the software products used presented in the group management report

In our opinion, on the basis of the knowledge obtained in the audit

- the accompanying consolidated financial statements comply, in all material respects, with the IFRS Accounting Standards issued by the International Accounting Standards Board (IASB)(hereafter “IFRS Accounting Standards”), as adopted by the EU, and the additional requirements of German commercial law pursuant to Article 315e HGB (Handelsgesetzbuch: German Commercial Code) and give a true and fair view of the assets, liabilities and financial position of the Group as at December 31, 2024 and of its financial performance for the financial year from January 1 to December 31, 2024 and
- the accompanying group management report as a whole provides an appropriate view of the Group’s position. In all material respects, this group management report is consistent with the consolidated financial statements, complies with German legal requirements and appropriately presents the opportunities and risks of future development. Our audit opinion on the group management report does not cover the content of the above-mentioned unaudited parts of the group management report.

Pursuant to Article 322 Paragraph 3 Clause 1 HGB, we declare that our audit has not led to any reservations relating to the legal compliance of the consolidated financial statements and of the group management report.

**Basis for the Audit Opinions**

We conducted our audit of the consolidated financial statements and of the group management report in accordance with Article 317 HGB and in compliance with German Generally Accepted Standards for Financial Statement Audits promulgated by the Institut der Wirtschaftsprüfer [Institute of Public Auditors in Germany] (IDW). Our responsibilities under those requirements and principles are further described in the “Auditor’s Responsibilities for the Audit of the Consolidated Financial Statements and of the Group Management Report” section of our auditor’s report.

We are independent of the Group Companies in accordance with the requirements of German commercial and professional law, and we have fulfilled our other German professional responsibilities in accordance with these requirements. We believe that the audit evidence we have obtained is sufficient and appropriate to provide a basis for our audit opinions on the consolidated financial statements and on the group management report.

### Other Information

The legal representatives are responsible for the other information. The other information comprises:

- the above-mentioned unaudited content of the group management report
- all other parts of the annual report, but not the consolidated financial statements, not the audited content of the group management report, and not our Independent Auditor's Report.

Our audit opinions on the consolidated financial statements and group management report do not cover the other information and consequently we do not express an audit opinion or any other form of assurance conclusion on this subject.

In connection with our audit, our responsibility is to read the other information and, in doing so, to consider whether the other information

- is materially inconsistent with the consolidated financial statements, the combined management report or our knowledge obtained in the audit, or
- otherwise appears to be substantially misstated.

If, based on the work we have performed, we conclude that there is a material misstatement of this information, we are required to report on that fact. We have nothing to report in this regard.

### Responsibilities of the Legal Representatives and the Administrative Board for the Consolidated Financial Statements and the Group Management Report

The executive directors are responsible for the preparation of the consolidated financial statements that comply, in all material respects, with the requirements of IFRS Accounting Standards as adopted by the EU and the additional requirements of German commercial law pursuant to Article 315e Paragraph 1 HGB, and that the consolidated financial statements give a true and fair view of the assets, liabilities, financial position and financial performance of the Group in compliance with these accounting principles. In addition, the legal representatives are responsible for such internal control as they have determined necessary to enable the preparation of consolidated financial statements that are free from material misstatement, whether due to fraud (i.e., fraudulent financial reporting and misappropriation of assets) or error.

In preparing the consolidated financial statements, the legal representatives are responsible for assessing the Group's ability to continue as a going concern. They also have the responsibility for disclosing, as applicable, matters related to going concern. In addition, they are responsible for using the going concern basis of accounting, unless the intention is to liquidate the Group or to cease operations, or there is no realistic alternative but to do so.





Furthermore, the legal representatives are responsible for the preparation of the group management report that as a whole provides an appropriate view of the Group's position and is, in all material respects, consistent with the consolidated financial statements, complies with German legal requirements, and appropriately presents the opportunities and risks of future development. In addition, the executive directors are responsible for such arrangements and measures (systems) as they have considered necessary to enable the preparation of a group management report that is in accordance with the applicable German legal requirements, and to be able to provide sufficient appropriate evidence for the assertions in the group management report.

The administrative board is responsible for overseeing the Company's financial reporting process for the preparation of the consolidated financial statements and of the group management report.

**Auditor's Responsibilities for the Audit of the Consolidated Financial Statements and of the Group Management Report**

Our objectives are to obtain reasonable assurance about whether the consolidated financial statements as a whole are free from material misstatement, whether due to fraud or error, and whether the group management report as a whole provides an appropriate view of the Group's position and, in all material respects, is consistent with the consolidated financial statements and the knowledge obtained in the audit, complies with the German legal requirements and appropriately presents the opportunities and risks of future development, as well as to issue an auditor's report that includes our audit opinions on the consolidated financial statements and on the group management report.

Reasonable assurance is a high level of assurance but is not a guarantee that an audit conducted in accordance with Article 317 HGB and in compliance with German Generally Accepted Standards for Financial Statement Audits promulgated by the Institut der Wirtschaftsprüfer (IDW) will always detect a material misstatement. Misstatements can arise from fraud or error and are considered material if, individually or in the aggregate, they could reasonably be expected to influence the economic decisions of users taken on the basis of these consolidated financial statements and this group management report.

We exercise professional judgment and maintain professional scepticism throughout the audit. We also:

- Identify and assess the risks of material misstatement of the consolidated financial statements and of the group management report, whether due to fraud or error, design and perform audit procedures responsive to those risks, and obtain audit evidence that is sufficient and appropriate to provide a basis for our audit opinions. The risk of not detecting a material misstatement resulting from fraud is higher than the risk of not detecting a material misstatement resulting from error, as fraud may involve collusion, forgery, intentional omissions, misrepresentations, or the override of internal controls.
- Obtain an understanding of internal control relevant to the audit of the consolidated financial statements and of arrangements and measures relevant to the audit of the group management report in order to design audit procedures that are appropriate in the circumstances, but not for the purpose of expressing an audit opinion on the effectiveness of internal control or these arrangements and measures.

- Evaluate the appropriateness of accounting policies used by the executive directors and the reasonableness of estimates made by the executive directors and related disclosures.
- Conclude on the appropriateness of the executive directors' use of the going concern basis of accounting and, based on the audit evidence obtained, whether a material uncertainty exists related to events or conditions that may cast significant doubt on the Group's ability to continue as a going concern. If we conclude that a material uncertainty exists, we are required to draw attention in the auditor's report to the related disclosures in the consolidated financial statements and in the group management report or, if such disclosures are inadequate, to modify our respective audit opinions. Our conclusions are based on the audit evidence obtained up to the date of our auditor's report. However, future events or conditions may cause the Group to cease to be able to continue as a going concern.
- Evaluate the overall presentation, structure and content of the consolidated financial statements, including the disclosures, and whether the consolidated financial statements present the underlying transactions and events in a manner that the consolidated financial statements give a true and fair view of the assets, liabilities, financial position and financial performance of the Group in compliance with IFRS Accounting Standards as adopted by the EU, and the additional requirements of German commercial law pursuant to Article 315e Paragraph 1 HGB.
- Obtain sufficient suitable audit evidence for the accounting information of the Companies or business activities within the Group to express audit opinions on the consolidated financial statements and the group management report. We are responsible for the direction, supervision, and performance of the group audit. We are solely responsible for our audit opinions.
- Evaluate the consistency of the group management report with the consolidated financial statements, its conformity with German law, and the view of the Group's position it provides.

- Perform audit procedures on the prospective information presented by the executive directors in the group management report. On the basis of sufficient appropriate audit evidence, we evaluate, in particular, the significant assumptions used by the executive directors as a basis for the prospective information, and evaluate the proper derivation of the prospective information from these assumptions. We do not express a separate audit opinion on the prospective information and on the assumptions used as a basis. There is a substantial unavoidable risk that future events will differ materially from the prospective information.

We communicate with those charged with governance regarding, among other matters, the planned scope and timing of the audit and significant audit findings, including any significant deficiencies in internal control that we identify during our audit.“

Stuttgart, March 5, 2025

dhpg GmbH  
Wirtschaftsprüfungsgesellschaft

Erlenkamp  
Wirtschaftsprüfer

Riedhammer  
Wirtschaftsprüfer

**Report from the Administrative Board of Mensch und Maschine Software SE, Wessling, according to section 47 para 3, SE implementing law (SE-IL) in conjunction with section 171 para 2, AktG (German Companies act)**

The Administrative Board (Verwaltungsrat) will report to the shareholders' meeting according to section 47 para 3, SE implementing law (SE-IL) in conjunction with section 171 para 2, AktG (German Companies act) as follows:

The Administrative Board fulfilled all its obligations as incumbent, pursuant to the corresponding statutes and by-laws, and including the ongoing advice and supervision of the company's Managing Directors. The Administrative Board was involved in all decisions of principal importance for the company. The strategic direction of the M+M group was closely aligned between the Managing Directors and the Administrative Board.

The Managing Directors informed the Administrative Board, orally or in writing, in a regular, timely and extensive manner about all essential matters concerning the short term planning, the actual course of business as well as the financial and earnings situation.

Based on detailed management reports, all business cases significant and essential for the M+M group have been discussed in depth, also concerning the development of the individual subsidiaries. Discrepancies in the course of business from the plan have been discussed intensively.

During fiscal year 2024, four Administrative Board meetings took place on March 12, May 8, July 19 and October 16, 2024.

In particular, the following matters were discussed between the Administrative Board and the Managing Directors:

- Development and maintenance of the group's own software technology
- Impact of decisions by the main supplier Autodesk on M+M
- Improvement of the individual subsidiaries' operating profitability
- Handover from founder Adi Drotleff to the Group Management Board
- Dividend policy



The Administrative Board received reports about the development of the risk management system; existing risks and their provision were explained by the Managing Directors.

The Administrative Board was also informed in detail about events of material importance in between the regular meetings.

Due to the size of the Board, there were no additional committees. An efficiency test for the activities of the Administrative Board was not explicitly conducted, because improvement processes are constantly discussed and translated into action.

The annual report of Mensch und Maschine Software SE as of December 31, 2024, as well as the group annual report as of December 31, 2024, including the management report for the group was set up by the Managing Directors and audited by dhpg GmbH Wirtschaftsprüfungsgesellschaft, Stuttgart, and endorsed with an unqualified audit opinion.

The Managing Directors' set up and the auditing reports from the auditing firm were available to all members of the Administrative Board.

The auditor took part in the annual fiscal year report meeting on March 10, 2025, and reported upon all significant results of the audit.

The Administrative Board reviewed the annual report and group annual report, the management and group management report and the Managing Directors' suggestion for the use of the net income for the year, and agreed to the annual report and group annual report, raising no objections after its own review.

The Administrative Board has approved the annual report and group annual report, and agreed the Managing Directors' suggestion for the use of the net income for the year.

The Administrative Board would like to thank all employees for their engagement in fiscal year 2024.

Wessling, March 2025  
The Administrative Board

Adi Drotleff  
Chairman

 Addresses

Company	Street	Town	Telephone	Telefax	Internet
<b>Mensch und Maschine Software SE</b>	Argelsrieder Feld 5	D-82234 Wessling	+49 (0) 81 53 / 9 33 - 0	+49 (0) 81 53 / 9 33 - 100	www.mum.de
<b>Mensch und Maschine Deutschland GmbH</b>	Argelsrieder Feld 5	D-82234 Wessling	+49 (0) 81 53 / 9 33 - 0	+49 (0) 81 53 / 9 33 - 100	www.mum.de
	Friesenweg 20	D-22763 Hamburg	+49 (0) 40 / 89 80 78 - 0	+49 (0) 40 / 89 80 78 - 22	
	Rotenburger Straße 3	D-30659 Hannover	+49 (0) 5 11 / 22 06 17 - 76	+49 (0) 5 11 / 22 06 17 - 99	
	Martin-Schmeißer-Weg 10	D-44227 Dortmund	+49 (0) 231 / 9 97 63 57 - 0	+49 (0) 231 / 9 97 63 57 - 9	
	Crottorfer Straße 47a	D-51580 Reichshof	+49 (0) 22 97 / 91 14 - 0	+49 (0) 22 97 / 91 14 - 22	
	Neue Jülicher Straße 60	D-52353 Düren	+49 (0) 24 21 / 3 88 90 - 0	+49 (0) 24 21 / 3 88 90 - 11	
	Am Hohenwiesenweg 1	D-63679 Schotten	+49 (0) 60 44 / 98 91 98	+49 (0) 60 44 / 95 11 73	
	Wandersmannstraße 68	D-65205 Wiesbaden	+49 (0) 6 11 / 97 49 18 - 0	+49 (0) 6 11 / 97 49 18 - 19	
	In den Fritzenstücker 2	D-65549 Limburg	+49 (0) 64 31 / 92 93 - 0	+49 (0) 64 31 / 92 93 - 29	
	Werner-von-Siemens-Allee 4	D-66115 Saarbrücken	+49 (0) 6 81 / 97 05 96 - 0	+49 (0) 6 81 / 97 05 96 - 10	
	Carl-Mayer-Straße 1	D-73230 Kirchheim/Teck	+49 (0) 70 21 / 9 34 88 - 20	+49 (0) 70 21 / 9 34 88 - 99	
	Im Kleinfeld 12a	D-79189 Bad Krozingen	+49 (0) 7 61 / 40 13 61 - 0	+49 (0) 7 61 / 40 13 61 - 10	
	Gabelweg 6	D-88046 Friedrichshafen	+49 (0) 75 41 / 38 14 - 0	+49 (0) 75 41 / 38 14 - 14	
	Flataustraße 14	D-90411 Nürnberg	+49 (0) 911 39 901 - 0	+49 (0) 81 53 / 9 33 - 100	
<b>Mensch und Maschine Infrastruktur GmbH</b>	Andreas-von-Renner Platz 2	D-71254 Ditzingen	+49 (0) 71 56 / 1 76 74 - 0		www.mum.de
<b>Mensch und Maschine acadGraph GmbH</b>	Fritz-Hommel-Weg 4	D-80805 München	+49 (0) 89 / 3 06 58 96 - 0	+49 (0) 89 / 3 06 58 96 - 20	www.acadgraph.de
	Kohlgartenstraße 15	D-04315 Leipzig	+49 (0) 3 41 / 30 85 47 - 0	+49 (0) 3 41 / 30 85 47 - 20	
	Charlottenstraße 65	D-10117 Berlin	+49 (0) 30 / 8 91 10 08	+49 (0) 30 / 8 93 17 08	
	Oststraße 88	D-22844 Norderstedt	+49 (0) 40 / 43 25 79 - 0	+49 (0) 40 / 43 25 79 - 79	
	Otto-Brenner-Straße 196	D-33604 Bielefeld	+49 (0) 5 21 / 2 81 - 63	+49 (0) 5 21 / 2 81 - 64	
	Poststraße 10	D-34587 Felsberg	+49 (0) 55 62 / 93 14 41 44	+49 (0) 28 62 / 92 95 - 20	
	Neuer Zollhof 3	D-40221 Düsseldorf	+49 (0) 2 11 / 1 57 91 77	+49 (0) 2 11 / 15 96 93 65	
	Stockumer Straße 475	D-44227 Dortmund	+49 (0) 2 31 / 56 03 10 - 40	+49 (0) 2 31 / 7 75 77 38	
	Dülmener Weg 221	D-46325 Borken	+49 (0) 28 61 / 6 80 21 - 0	+49 (0) 28 61 / 6 80 21 - 20	
	Goetheplatz 5	D-99423 Weimar	+49 (0) 36 41 / 6 35 52 - 5	+49 (0) 36 41 / 6 35 52 - 4	
<b>Mensch und Maschine At Work GmbH</b>	Gewerbepark 18	D-49143 Bissendorf	+49 (0) 5 41 / 4 04 11 - 0	+49 (0) 5 41 / 4 04 11 - 4	www.work-os.de
<b>customX GmbH</b>	Auf den Sechsmorgen 25	D-65589 Hadamar	+49 (0) 64 33 / 94 761 - 0		www.customx.de
<b>Mensch und Maschine Scholle GmbH</b>	Rheinlandstraße 24	D-42549 Velbert	+49 (0) 20 51 / 9 89 00 - 20	+49 (0) 20 51 / 9 89 00 - 29	www.scholle.de
<b>Mensch und Maschine Austria GmbH</b>	Argentinierstraße 64/5	A-1040 Wien	+43 (0) 1 / 5 04 77 07 - 0	+43 (0) 1 / 5 04 77 07 - 27	www.mum.at
	SOHO 2 - Grabenweg 68	A-6020 Innsbruck	+43 (0) 52 23 / 4 20 08	+43 (0) 33 85 / 6 60 01 33	
	Hartert Straße 1	A-8053 Graz	+43 (0) 3 16 / 93 12 55	+43 (0) 33 85 / 6 60 01 33	
	Großwilfersdorf 102/1	A-8263 Großwilfersdorf	+43 (0) 33 85 / 6 60 01	+43 (0) 33 85 / 6 60 01 33	
<b>Mensch und Maschine Schweiz AG</b>	Zürichstrasse 25	CH-8185 Winkel	+41 (0) 44 / 8 64 19 00	+41 (0) 44 / 8 64 19 01	www.mum.ch
	Route du Simplon 16	CH-1094 Paudex	+41 (0) 21 / 7 93 20 32	+41 (0) 21 / 7 93 20 39	
	Reiherweg 2	CH-5034 Suhr	+41 (0) 62 / 8 55 60 60	+41 (0) 62 / 8 55 60 00	
	Baslerstrasse 30	CH-8048 Zürich	+41 (0) 43 / 3 44 12 12	+41 (0) 43 / 3 44 12 11	

 Events

April 23, 2025	Quarterly report Q1/2025
May 8, 2025	Annual shareholders' meeting
July 23, 2025	Half year report 2025
October 21, 2025	Quarterly report Q3/2025
March 17, 2026	Annual report 2025

## Investor contact

Mensch und Maschine Software SE  
 Markus Pech, CFO  
 Argelsrieder Feld 5  
 D-82234 Wessling

Phone +49 (0) 81 53 / 9 33 - 0  
 Telefax +49 (0) 81 53 / 9 33 - 1 04  
 E-Mail investor-relations@mum.de  
 Internet www.mum.de/investor



Addresses					
Company	Street	Town	Telephone	Telefax	Internet
Man and Machine France	168-170 rue Paymond Losseraud	75014 Paris	+33 (0) 1 /53 72 88 00	+33 (0) 1 /53 72 88 01	www.manandmachine.fr
Man and Machine UK	Unit 8 Thame 40 Jane Morbey Road, Thame,	Oxfordshire, OX9 3RR	+44 (0) 18 44 /26 18 72	+44 (0) 18 44 /21 67 37	www.manandmachine.co.uk
Man and Machine Italy	Via Torri Bianche, 1 Corso Unione Sovietica, 612/20 Via Umberti Forti 1 - Mantacchiello	20871 Vimercate (MI) 10135 Torino (TO) 56121 Pisa (PI)	+39 (0) 39 /6 99 94 1 +39 (0) 11 /34 71 838 +39 (0) 50 /9 65 61 62	+39 (0) 39 /6 99 94 44 +39 (0) 11 /3 47 31 77 +39 (0) 39 /6 99 94 44	www.mum.it
Man and Machine Poland	ul. Zeromskiego 52	90-626 Lodz	+48 (0) 42 /2 91 33 33		www.mum.pl
Man and Machine Romania	Str. Remus Nr. 12, Sector 3	030685 Bucuresti	+40 (0) 31 /2 28 80 88	+40 (0) 31 /28 80 91	www.manandmachine.ro
Mensch und Maschine Hungary	Fenyves sor. 7	9400 Sopron	+36 (0) 99 /330 300		www.mum.co.hu
Mensch und Maschine Mechatronik GmbH	Öschstraße 33	D-73072 Donzdorf	+49 (0) 71 62 /94 97 85 - 0	+49 (0) 71 62 /94 97 85 - 10	www.mum.de
DATAflor Software AG	August-Spindler-Straße 20	D-37079 Göttingen	+49 (0) 5 51 /5 06 65 - 50	+49 (0) 5 51 /5 06 65 - 59	www.dataflor.de
SOFISTIK AG	Parkring 2	D-85748 Garching	+49 (0) 89 31 58 78 - 0		www.sofistik.de
SOFISTIK AG	Flataustraße 14	D-90411 Nürnberg	+49 (0) 911 39 901 - 0		www.sofistik.de
OPEN MIND Technologies AG	Argelsrieder Feld 5	D-82234 Wessling	+49 (0) 81 53 /93 35 00	+49 (0) 81 53 /93 35 01	www.openmind-tech.com
OPEN MIND Technologies Schweiz GmbH	Frauenfelderstrasse 37	CH-9545 Wängi	+41 (0) 44 /8 60 30 50	+41 (0) 44 /8 60 30 51	www.openmind-tech.com
OPEN MIND Technologies UK Ltd.	Unit 3, Bicester Business Park Telford Road – Bicester	Oxfordshire OX26 4LN	+44 (0) 18 69 /29 00 03		www.openmind-tech.com
OPEN MIND Technologies Italia S.r.l.	Via Pomè 14	20017 Rho (MI)	+39 / (0) 2 /93 16 25 03	+39 / (0) 2 /93 18 44 29	www.openmind-tech.com
OPEN MIND Technologies France S.a.r.l.	3, avenue Edouard Herriot, Parc Elitech, Bat B	69400 Limas	+33 (0) 4 /87 01 85 01	+33 (0) 4 /84 50 80 71	www.openmind-tech.com
OPEN MIND Technologies Spain, S.L.U.	C/ Vilarós nº5, D3	08022 Barcelona	+34 (0) 932 17 80 50		www.openmind-tech.com
OPEN MIND Technologies Portugal Unipessoal, LDA	Edifício Centro de Negócios MAPER, Fração N e O, Estr. Nacional 242, Km 9,2	2430-074 Marinha Grande	+351 244 023 359		www.openmind-tech.com
OPEN MIND Technologies Asia Pacific Pte Ltd.	MOVA Building, 22 Jalan Kilang #03-00	Singapore 159419	+65 67 42 95 56		www.openmind-tech.com
OPEN MIND Technologies Japan K.K.	Albergo Musashino B101, 3-2-1 Nishikubo, Musashino-shi	180-0013 Tokyo	+81 50 53 70 10 18		www.openmind-tech.com
OPEN MIND CAD/CAM Technologies India Private Ltd	#610&611, 6st Floor, 'B' Wing, No.6 Mittal Tower, M.G. Road	Bangalore 560 001	+91 80 26 76 69 99	+91 80 26 76 92 16	www.openmind-tech.com
OPEN MIND Technologies Taiwan Inc.	Room F, 4th Floor, No.1, Yuandong Rd. New Taipei City 22063	Taiwan, R.O.C.	+886 2 29 57 68 98	+886 2 29 57 68 08	www.openmind-tech.com
OPEN MIND Technologies China Co.Ltd	Suite 1608, Zhong Rong International Plaza No.1088 South Pudong Road	Shanghai 200120	+86 21 58 87 65 72	+86 21 58 87 65 73	www.openmind-tech.com
OPEN MIND Technologies USA, Inc.	1492 Highland Avenue, Unit 3	Needham MA 02492	+1 (888) 516 12 32	+1 (270) 912 - 58 22	www.openmind-tech.com
OPEN MIND Tecnologia Brasil LTDA	Av. Andromeda, 885 SL2021	06473-000 – Alphaville Empresarial Barueri – Sao Paulo	+55 11 24 24 85 80	+55 11 24 24 85 81	www.openmind-tech.com
OPEN MIND Technologies Benelux BV	Titaniumlaan 86	5221 CK 's-Hertogenbosch	+31 73 6480-166	+31 73 6480-169	www.openmind-tech.com
OPEN MIND Technologies Scandinavia AB	C/O ISO Tool AB Enhörningsvägen 8 A	281 43 Hässleholm			www.openmind-tech.com
Hummingbird Systems GmbH	Frankenstraße 152	90461 Nürnberg	+49 911 237 94 60		www.hummingbird-systems.com

## The M+M Group as a training provider for its customers

Participants: Users of M+M software solutions and decision-makers

Offer types: Seminar calendar or tailor-made / on premise or online

With around 40,000 participant days per year, the training business contributes 8-9% of the M+M group gross profit. Extensive seminar calendars for either online or on premise participation at our approximately 75 locations in over 20 countries on three continents are supplemented by individual and tailor-made seminar concepts for major customers.

In addition to basic and expert courses for users of M+M software in the areas of CAD/CAM/CAE, BIM/Engineering, Gardening/Landscape/Earthworks and Infrastructure as well as the entire Autodesk software portfolio, our training spectrum also includes BIM Ready for the architecture/construction sector, which has been successful for over 10 years, and more recently CIM Ready for the industrial/manufacturing sector.

These two training lines for the innovative project planning methods BIM (Building Information Management) and CIM (Computer Integrated Manufacturing) are not only aimed at users, but also include modules for project management and decision makers.

**bim** ✓ ready  
**cm** ✓ ready



**mensch** ✘ **maschine**  
Software

**Mensch und Maschine  
Software SE**

Argelsrieder Feld 5  
D-82234 Wessling

Tel. +49 (0) 81 53 / 9 33 - 0

Fax +49 (0) 81 53 / 9 33 - 100

[www.mum.de](http://www.mum.de)